

Price \$4.00

2024-2025

AUTO CITY CLASSIC



Visit our website at
www.autocityclassic.com
or scan the QR code



58 CHEV PARTS SPECIALISTS



*prices subject to change

AUTO CITY CLASSIC, INC.

Thanks for requesting our parts catalog. It is filled with many new parts as well as our usual supply of quality used parts for your 58 Chevy. We, at Auto City Classic, started collecting 58 Chevrolet parts in the late 1970's. At that time there was very little interest in the 58 Chevy. All the attention was focused on the 55, 56 and 57 Chevys. Through our interest, we have become the largest manufacturer of 1958 Chevrolet parts exclusively. Auto City Classic has done 20 frame off restorations and with this experience and through trial and error, we have gained the knowledge to know what is needed to restore a 58 Chev. Our reproduction parts are exact and correct and have been tried and tested by us and many satisfied customers. With over 100 58 Chev parts cars, we also have one of the largest selections of used parts available. Whether it's a bolt or a complete interior, we can supply your 58 Chevy with quality, dependable parts. We are constantly introducing new products, so if you don't see what you need or if you have any questions regarding what is correct, give us a call. We will be glad to help. We hope you will be pleased with our products.

AUTO CITY CLASSIC, INC.
28433 Highway 65 N.E.
Isanti, Minnesota 55040

Business Hours:
Mon. - Fri. 8:00 a.m. - 5:30 p.m. CST

763-444-5880

Fax: 763-444-5985

e-mail: autocity@att.net

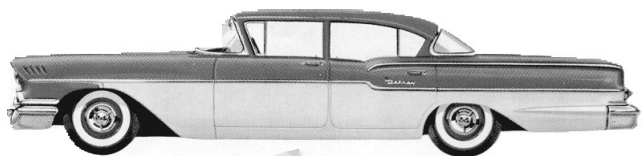
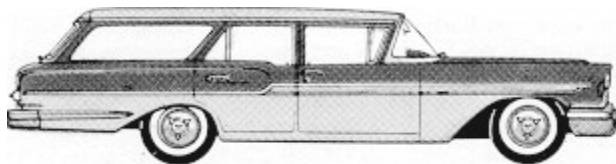
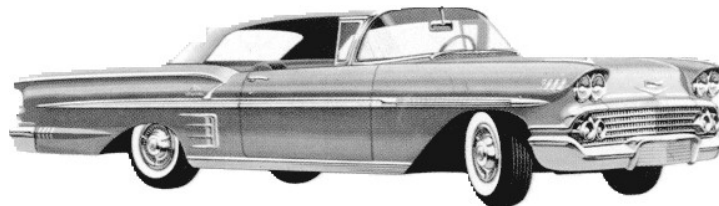
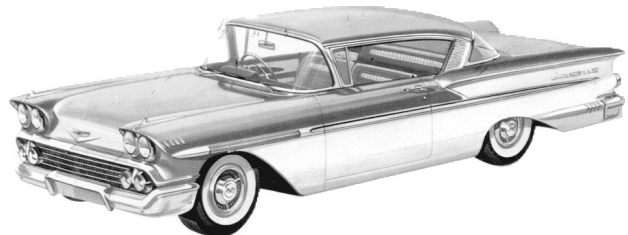
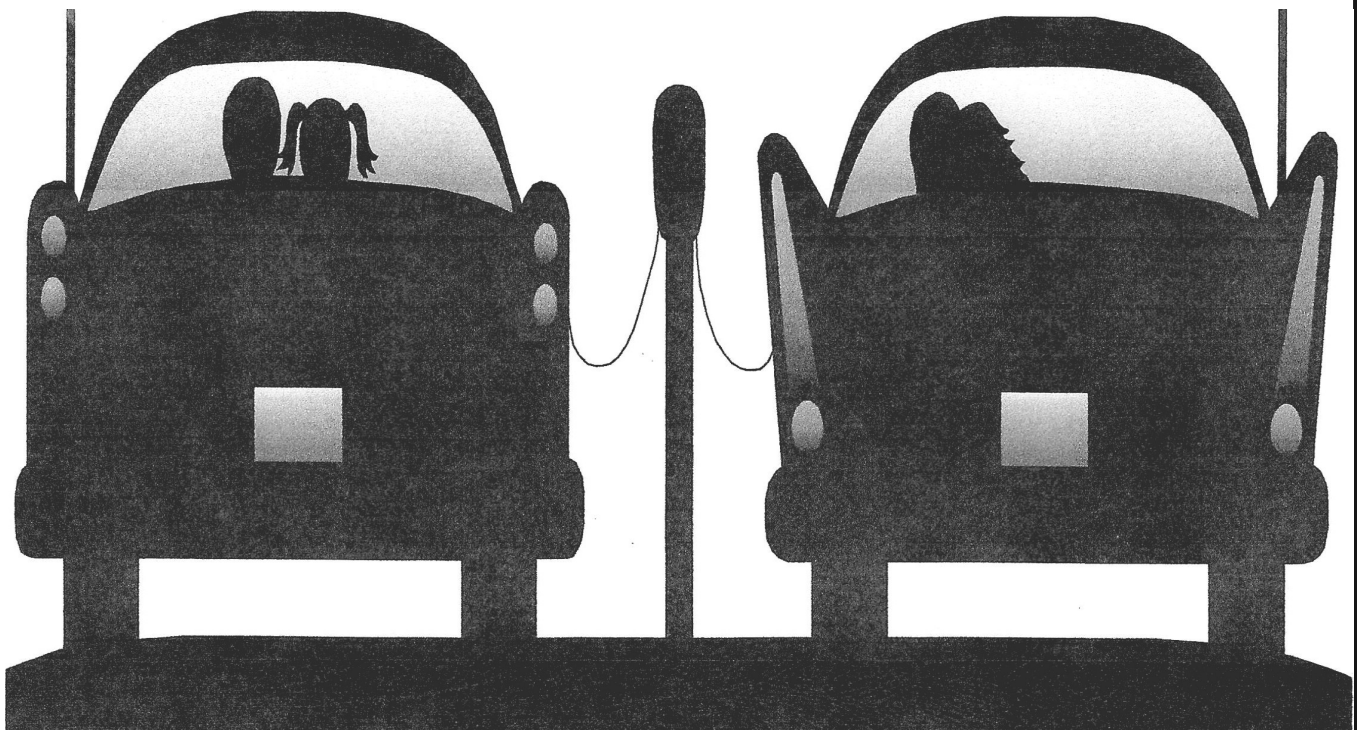

TABLE OF CONTENTS

AIR CLEANERS	15
BRAKES	11, 12
CLIPS - RETAINERS	24
CONTINENTAL KIT	26
CONVERTIBLE ONLY PARTS	21, 22
CUSTOM ITEMS - MISC	27
DECALS	24
DIAGRAMS	29 - 35
GLASS	9
ELECTRICAL	10
ENGINE - MECHANICAL	14
EXHAUST	15
EXTERIOR PARTS	1, 2, 3
FUEL	13
HEATING & COOLING	16
INDEX	38, 39
INTERIOR ITEMS	4, 5, 6, 7, 8
LITERATURE	25
ORDERING INFORMATION	40
POWER STEERING	17
SHEET METAL	19, 20
SUSPENSION	18
TIRES & WHEELS	18
TRANSMISSION	14
WEATHERSTRIP - GASKETS	23
MORE THAN 58 CHEVY PARTS	36, 37





GRILLE

3072 New Exact Reproduction Grille Looks Great \$ 599.00

LICENSE PLATE FRAME

1963 Front License Plate Bracket \$ 22.00

BUMPERS - Bumper Pieces are USA Re-chromed

- 1960 Rear Bumper Filler Panel \$ 88.00
- 1961L Left Rear Bumper End Re-chrome Exch Call
- 1961R Right Rear Bumper End Re-chrome Exch Call
- 1962 Center Rear Bumper Re-chrome Exch Call
- 1962S 3 Pc Rear Bumper Set Re-chrome Exch Call
- 3447 3 Pc Rear Bumper Set Reproduction \$ 499.00
- 3448L Left Rear Bumper End - Reproduction \$ 154.00
- 3448R Right Rear Bumper End - Reproduction \$ 154.00
- 1964L Left Front Bumper End Re-chrome Exch Call
- 1964R Right Front Bumper End Re-chrome Exch Call
- 1965 Center Front Bumper Re-chrome Exch Call
- 1965S 3 Pc Front Bumper Set Re-Chromed Exch Call
- 3449 3 Pc Front Bumper Set - Reproduction \$ 599.00
- 1966 Bumper Bolts with Nuts Ea \$ 3.00
- 1966S Bumper Bolt Set of 8 \$ 21.00
- 1967 Front Bumper Filler Panel- Pwdr Coat. \$ 89.00
- 3446L Front Inner Bumper Bracket- left \$ 29.00
- 3446R Front Inner Bumper Bracket - right \$ 29.00
- 3406L Front Outer Bumper Bracket - left \$ 29.00
- 3406R Front Outer Bumper Bracket - right \$ 29.00
- 31132 Outer Rear Bumper Brace Used on Left \$ 28.00
- 3132 Inner Rear Bumper Brace - Right \$ 26.00
- 3131 Inner Rear Bumper Brace - Left \$ 26.00
- 3138 Rear Bumper Bracket - Left & Rt \$ 19.00

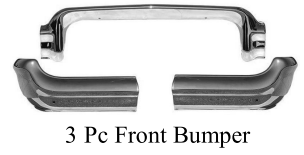

3 Pc Front Bumper



1962 Rear Center Bumper



1964L 1964R



3406L & 3406R



1963 Frt License Plate Brkt



1967 Front Bumper Filler



1955 Park Light Bezel



3072 New Reproduction Grille



1950 Hood Bar



RH Fender Ext 1953 RH Hood Bar 1952



1956 Hood V

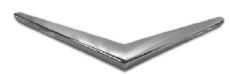

1957 Trunk V



3071 Upper Quarter Bead Molding

POT METAL- ALL NEW REPRODUCTION PARTS

- 1950 Hood Bar (center) New Reproduction \$ 250.00
- 1951 Hood Bar Left (left eyebrow) New \$ 92.00
- 1952 Hood Bar Right (right eyebrow) New \$ 92.00
- 1953 Fender Extension - Rt (pass. side) New \$ 66.00
- 1954 Fender Extension - Lt (driver side) New \$ 66.00
- 1955 Park Light Bezel - "New Reproduction" \$ 169.00 ea
- Specify right or left when ordering Per Side
- 1956 Hood V New \$ 44.00
- 1957 Trunk V New \$ 40.00

STAINLESS STEEL MOLDINGS

" EXACT REPRODUCTIONS"

- 2963 "S" Moldings - Right or Left Ea. \$ 169.00
- 3071 Upper Quarter Bead Molding Ea. \$ 208.00
- Right & Left Pr. \$ 399.00
- 3070 Front Fender Spear "Reconditioned" \$ CALL
- Exchange Needed Specify Rt. or Left

EXTERIOR SIDE DOOR & QTR MOLDINGS

- 1923 Complete Set of 8, Door & Qtr. Mldgs. \$ 459.00
- 1923A One Side only - 2 Door & 2 Quarters \$ 239.00
- 1923D Door Molding - Specify Upper or Lower Right or Left \$ 79.00
- 1923Q Quarter Molding - Specify Upper or Lower Right or Left \$ 79.00

EXTERIOR SIDE ALUMINUM INSERTS

- 6 piece side anodized aluminum inserts. Exact reproduction.
- 1921 AN EXCELLENT REPRODUCTION \$ 329.00



1921 Exterior Side Aluminium



1923 Set of 8 Door & Quarter Side Moldings

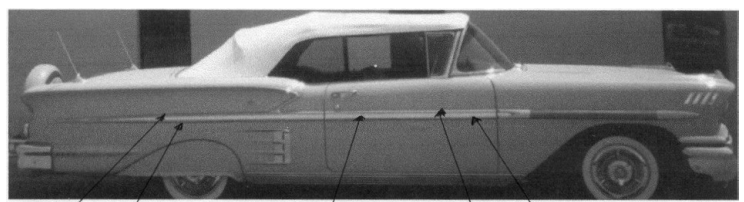

Upper & Lower Qtr Mldgs Insert Upper & Lower Dr. Mldg

800-828-2212



EXTERIOR TRIM & MIRRORS

1901	Impala Quarter Panel Flags	\$ 41.00	pr
1902	Impala Quarter Panel Script	\$ 42.00	pr
1957	Trunk V	\$ 40.00	
1904	Front Fender Ornament	\$ 77.50	pr
1905	6 Cylinder - Trunk Insert	\$ 42.00	
2905	6 Cylinder Trunk Emblem Assembly	\$ 135.00	
1906	6 Cylinder Hood Emblem Insert	\$ 55.00	
1906A	6 Cylinder Hood Emblem Assembly	\$ 149.00	
1907	Trunk Script "Chevrolet"	\$ 33.00	
1908	V-8 Hood Insert	\$ 27.00	
1917	V-8 Hood Emblem Assembly	\$ 59.00	
1956	Hood V- New	\$ 44.00	
1910	Front Fender Louvers Set of 8	\$ 61.00	
1913	Continental Kit Script "Chevrolet"	\$ 39.00	
1914	Continental Kit V	\$ 39.00	
1919	Door Rear View Mirror	\$ 59.00	
2901	Lower Rear Qtr. Louvers - Great Stainless Steel Reproduction Set of 8	\$ 94.00	
2902	Single Lower Qtr. Louver	\$ 12.00	
2903	Roof Rear Scallop Re-chromed	Call	
2904	Stainless Steel Fender Skirt Scuff Trim	\$ 25.00	pr
2984	Impala Rear window corner molding Ext molding for lower corner of the back glass (includes clip)	\$ 39.95	

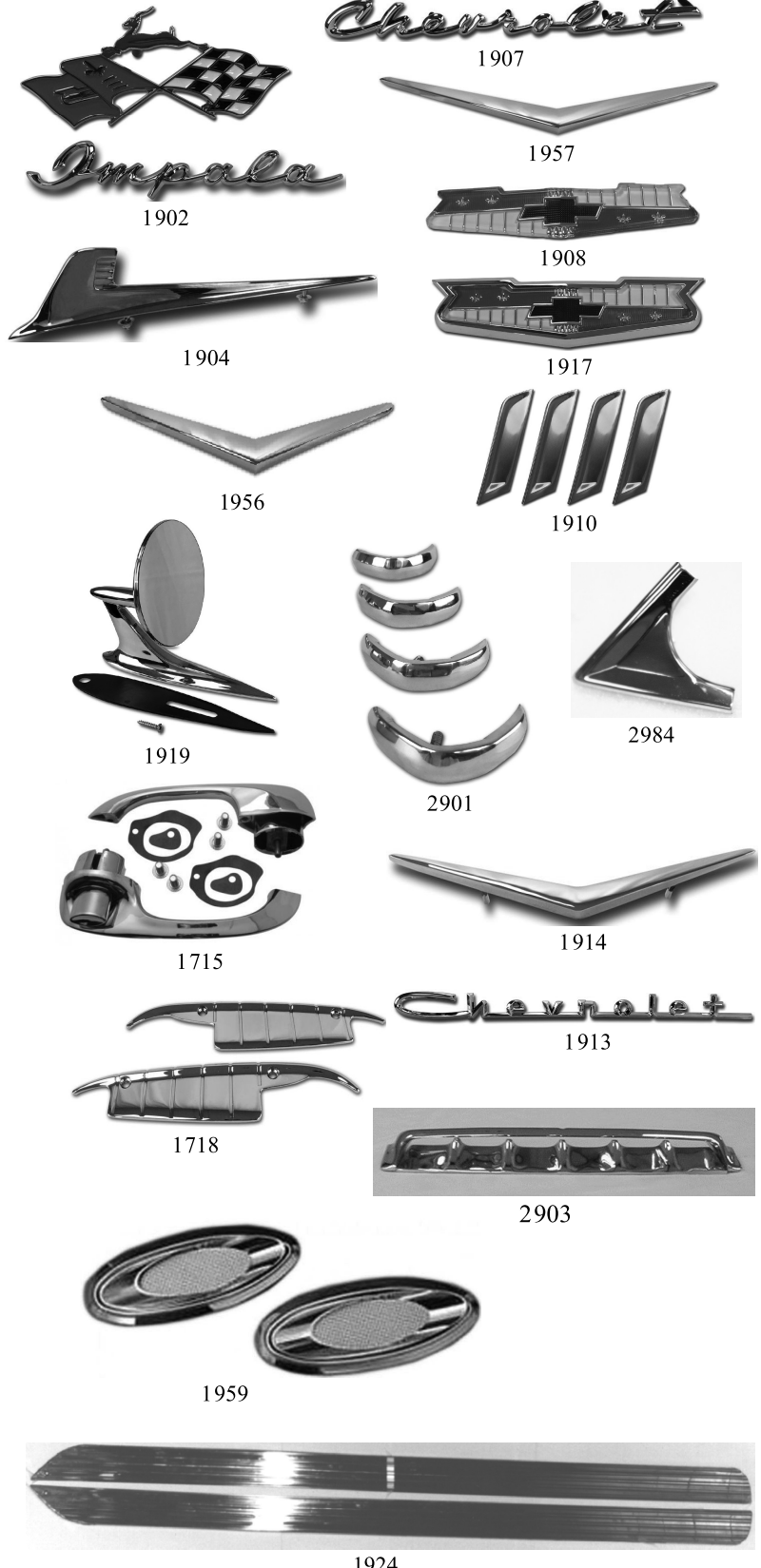

DOOR HANDLES

1715	Complete with buttons, hardware & gaskets. Show Quality - Triple Plated	\$ 99.00	pr.
1716	Door Handle Push buttons	\$ 12.50	pr.
1717	Door Lock Knob, Assorted colors	\$ 9.00	pr.
1718	Door Handle Shields with hardware	\$ 22.00	pr.
1719	Door Striker Plates	\$ 35.00	pr.
1713	Door Lock Set with Keys	\$ 42.00	

EXHAUST PORTS

These are a unique accessory that gives your 58 a classic look. This reproduction is of high quality polished stainless steel to keep that new look.

1959	\$ 99.00	pr.
------	----------	-----

STAINLESS STEEL ROCKER MOLDINGS

Made with high quality stainless pressed over a galvanized metal back as the originals were. The depth & width of the grooves are exact. This reproduction is exact right down to the clips used for mounting. No difference from NOS.

1924	Includes Clips	\$ 399.00	pr.
------	----------------	-----------	-----



**ORDERING IS EASY!
800-828-2212**



HOOD ITEMS

1740	Hood Insulation Pad Original Yellow	\$ 35.00
1740A	Hood Insulation Pad Original Black	\$ 35.00
1741	Retainer & Clips for insulation Pad	\$ 32.00
1742	Hood Pad Center Retainer Clip	\$ 15.00
4109	Hood Springs	\$ 42.00 pr

WIPERS

1701	Windshield Washer Hose Kit	\$ 16.00
1702	Windshield Wiper Blade	\$ 37.00 ea.
1703	Wiper Arms, Stainless, Rt. or Left	\$ 37.00 ea.
1704	Wiper Escutcheon Excellent Reprod.	\$ 26.00 ea.
1705	Wiper Escutcheon Gasket	\$ 4.00
5010	Wiper Escutcheon Nut	\$ 8.00 pr.
1706	Wiper motor to body rubber nuts with threaded center. Set of 4	\$ 6.00
1707	Wiper Motors - Rebuilt - Exchange	Call
89483	Wiper Motor Harness	\$ 20.00
1709	Wiper Arm Trans. Bushing with rubber seal 2 needed	\$ 3.25 ea.
1709S	Wiper Arm Trans. Bushing Seal Only	\$.50 ea.
1710	Wiper Arm Trans. Union Clip	\$ 2.00 ea.

HEADLIGHTS

1930	Headlight Bezel Trim Panels	\$ 90.00 pr
1931	Headlight Retainer Bucket -Used Only	Call
1932	Headlight Switch	\$ 30.00
1936	Headlight High Beam	\$ 20.00
1937	Headlight Low Beam	\$ 20.00
1938	Headlight Adjusting Kit With correct lower bucket springs	\$ 34.00
50114	Headlight Harness	\$ 98.00
58001	Headlight Connection Harness Set of 2	\$ 55.00

PARK LIGHTS

1944	Park Light Lens	\$ 9.00
1955	Park Light Bezel- New Reproduction - No cores needed Specify right or left when ordering Per Side	\$ 169.00 ea

TAILLIGHTS.

1940	6 pc. Taillight Assembly, with guide lens..Original style Inserts so original harness will plug in. Show quality!	\$ 269.00
1941	Impala Taillight Bezel only	\$ 23.00ea
2941	Bel Air/Biscayne Taillight Bezel Re-chromed	Call
1943	Taillight Lens - Red	\$ 7.50
1942	Back Up Lens	\$ 8.00
5003	Taillight Cup - Single Filament	\$ 12.00
1943S	Taillight & Backup Light Lens Set 4 red 2 Clear	\$ 42.00
5004	Taillight Cup - Dual Filament	\$ 12.00
1948	Taillight to Body Rubber Seal	\$ 8.00
1033	Taillight Lens Gasket	\$ 3.00
1034	Taillight & Back Glass Lens Gaskets Set of 6	\$ 17.50

TRUNK ITEMS

1730	Rubber Trunk Mat - Correct Pattern	\$ 199.00
1731	Left Trunk Cardboard Filler Panel	\$ 40.00
1732	Right Trunk Cardboard Filler Panel Used with Continental Kits	\$ 57.00
1733	Left & Right Filler Panels	\$ 68.00
1734H	Rear Seat Cardboard - Hardtop	\$ 26.00
1734C	Rear Seat Cardboard - Convertible	\$ 26.00
1734S	Rear Seat Cardboard - Sedan	\$ 26.00
1735	Trunk Lid Insulation Kit	\$ 39.00

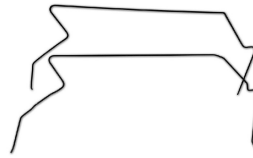

Retainers
Hood Pad
Center Clip

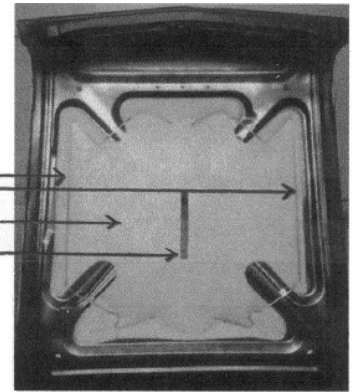

1742 Hood Pad Center Clip



1704



1710



Wiper Trans Arm, Union Clip & Bushing



4109 Hood Spring



1940

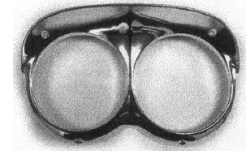

1930 Headlight Bezel



1034 6 Pc Taillight Lens Set



1955 Park Light Bezel

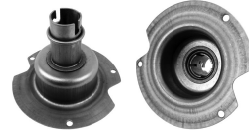

5003 Single Filament Tail light Cup



1941 Impala Taillight Bezel



1735 Truck Insulation Kit



2941 Non-Impala Taillight Bezel

If you don't see what you need, give us a call. 800-828-2212



RADIOS

NEW!! "WONDER BAR" RADIO NOS WASN'T THIS GOOD!

This new reproduction has the look of the original Wonder Bar radio with the performance you get with new technology. Great attention has been paid to every detail to make this visually the same as the original. The dial fonts are the same and there is no digital display. The wonder bar seeks up the dial to the top and then rapidly returns to the bottom to start over just like the original. The push buttons and tuning knobs work just like they were originally designed.

We have installed this radio in our cars and it sounds and works GREAT!

- 3601 Wonder Bar \$ 759.00
 - 1632 AM/FM Radio - Ken Harrison - 200 Watt \$ 229.00
- 6 AM & 6 FM Preset channels, Seek Auto Tune, Wireless Bluetooth, USB flash drive, Auto antenna power lead. Complete with diagram & installation instruction.



3601 New Wonderbar Radio



1632 Ken Harrison AM/FM

RADIO ITEMS

- 1627 Aluminum Radio Face Plate \$ 32.00
 - 1627B Aluminum Glove box Faceplate \$ 35.00
 - 1628 Radio Knob Bezels Only - 2 (no knobs) \$ 26.00
 - 1629 Rear Speaker Switch with Original Knob Call
 - 1672 Rear Speaker Switch Bezel \$ 33.00
 - 1630 Front Speaker - Original Style \$ 39.00
 - 1631 Rear Speaker - Fits stock position, 8 OHM \$ 39.95
 - 1633 Dual Speakers, 60watts Fits orig. opening \$ 45.00
 - 1634 Rear Working Antenna, cable, bezel, nut ,seal \$ 99.00
 - 1635 Rear Dummy Antenna, bezel, seal, nut & template \$ 99.00
 - 1636 Rear Antennal Nut \$ 10.00
 - 1637 Rear Antenna Bezel \$ 40.00
 - 1638 Rear Antenna Cable \$ 26.00
 - 1639 Rear Antenna Seal \$ 2.00
 - 1640 Rear Antenna Template \$ 18.00
 - 4104 Impala Rear Speaker Grille Assbly - Specify Color \$ 229.00
- Screen, Outer Chrome, Medallion Retainer, Script & Medallion
- 4105 Impala Rear Speaker Grille- Less Script & Medallion \$ 142.00
 - 4106 Impala Rear Speaker Grille Outer Chrome \$ 42.00
 - 4107 Impala Rear Spkr. Grille U shaped medallion retainer \$ 31.00
 - 4108 Impala Rear Speaker Grill Only \$ 31.00
 - 2912 Impala Rear Speaker Script \$ 62.00
 - 3201 Impala Speaker Screen Rear Medallion \$ 49.00



1630 Front Speaker



1627 Radio Face Plate



1633 Dual Speaker



1637 Antenna Bezel



1631 Rear Spkr.



4104 Complete Rear Speaker Grille



3201 Medallion

INSTRUMENT LENSES

- 1651 Speedometer Face \$ 58.00
 - 1652 Gasoline Face \$ 33.00
 - 1653 Temperature Face \$ 33.00
 - 1654 Clock Face \$ 33.00
- Trans Gear Indicator Illuminator
- 1655PG Powerglide \$ 33.50
 - 1655TG Turboglide \$ 33.50
 - 1656 Odometer Lens \$ 18.00
 - 1657 6 Piece Lens Set \$ 195.00
 - 1658 Radio Lens \$ 20.00

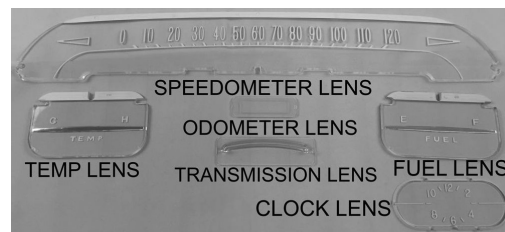

1657 6 Piece Instrument Lens Set

INSTRUMENT CLUSTER

- 5001 Restored Odometer Cluster. New guages, new odometer rebuilt speedo head, painted and detailed, with replated upper chrome \$ 799.00
- 5001A Reproduction Odometer and Speedo Needle Assembly \$ 289.00



5001A

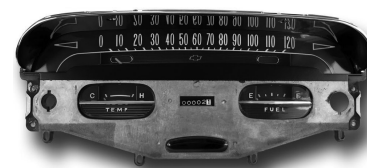

5001 Restored Original

ORDERING IS EASY! CALL 800-828-2212



DASH ALUMINUM RESTORATION KIT

1650A 100% Correct pattern as the original. Looks Great!

Aluminum. Helps cover small nicks & imperfections. \$139.00

DASH & STEERING COLUMN - MISC. ITEMS

4103	Clock - New Reproduction - Quartz but looks original & works	\$ 129.95
1627B	Aluminum Glove box Faceplate	\$ 35.00
4110	Temp Gauge - NEW Reproduction	\$ 69.00
4111	Fuel Gauge - NEW Reproduction	\$ 89.95
1659	Neutral Safety Switch	\$ 17.50
1660	Turn Signal Lever with Knob	\$ 10.00
1661	Ignition Lock Cylinder with Key	\$ 12.00
4112	Ignition Switch - NEW Reproduction	\$ 89.00
1662	Glove Box	\$ 36.00
1675	Glove Box Lock with Key	\$ 19.00
1676	Glove Box Lock Retainer with Screw	\$ 4.00
1677	Glove Box Light	\$ 19.00
1663	Turn Signal Activating Ring	\$ 8.00
1664	Cam Canceling	\$ 8.00
1915	Impala Horn Ring Center Medallion	\$ 49.00
1665	Impala Horn Ring Only	\$ 109.00
1665C	Impala Horn Ring Center	\$ 55.00
1667	Horn Kit Specify Model Please	\$ 18.00
3206	Horn Relay	\$ 28.00
1668	Dimmer Switch	\$ 21.00
1932	Headlight Switch	\$ 30.00
1669	Firewall Pad Cover with Fasteners	\$ 82.00
1670	Firewall Pad Cover Fasteners, 6 pcs.	\$ 8.00
1671	Dash Bezels (lights,ignition,wiper,lighter)	\$ 69.00
1673	Steering Wheel Paint Dividers - Set of 4	\$ 18.00
1674	Gear Shift Lever with Knob (Auto Only)	\$ 29.00
1678	Cigarette Lighter	\$ 44.00
3080	Automatic Shift Indicator	\$ 35.00
1912	Impala Dash Script	\$ 62.00
1916	Dash "Positraction" Emblem	\$ 65.00

Custom Steering Wheels & Tilt Columns - See Page 17

MISCELLANEOUS ITEMS & TRIM

4104	Impala Rear Speaker Grille Assembly Screen, Outer Chrome, Medallion Retainer, Script & Medallion	\$ 229.00
4105	Imp Rear Speaker Grille Only	\$ 142.00
4106	Impala Rear Speaker Grille Outer Chrome	\$ 42.00
4107	Impala Rear Spkr. Grille medallion retainer	\$ 31.00
4108	Impala Rear Speaker Grill Only	\$ 31.00
2912	Impala Rear Speaker Script	\$ 62.00
3201	Impala Speaker Screen Rear Medallion	\$ 49.00
1928	Impala Rear Ashtray with Slider Lid	\$ 25.00
1928A	Rear Ashtray Insert Only	\$ 10.00
2919	Coat Hooks	\$ 16.00 pr
1918	Vanity Mirror with "Chevrolet" Script	\$ 20.00
2917	Traffic Light Viewer	\$ 49.00
2918	Tissue Dispenser	\$ 125.00
1920	Non-Glare Rear View Mirror	\$ 24.00
1920D	Day-Night Rear View Mirror	\$ 75.00
1645C	Rear View Mirror Bracket - Convertible	\$ 65.00
1645H	Rear View Mirror Bracket - Hardtop	\$ 39.00

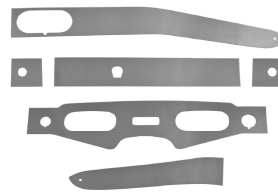

1650A Dash Aluminum



4103 New Clock



4112



4111



4110



1627B



1665C



1673



3080



1665



3206 Horn Relay



1678



1915



1916



2917



1671 Dash Bezels



1912 & 2912



1928



1645C



1928A



3201



2919

**If you don't see what you need,
give us a call. 800-828-2212**



INTERIOR DOOR ITEMS

NEW REPRODUCTIONS!

4101 Impala Interior Dr Pad Lower Stainless Trim	\$ 89.00 ea
4102 Impala Kick Panel Lower Stainless Trim	\$ 49.00 ea
3617RH Impala Armrest Only Right Side	\$ 99.00
3617LH Impala Armrest Only Left Side	\$ 99.00
Right & Left Armrest	\$ 189.00
Reproduction with original looking vinyl type grain & stitching.	
3616L Impala Armrest w/bezel,lens & end cap RH	\$ 189.00
3616R Impala Armrest w/bezel,lens & end cap LH	\$ 189.00
1713 Door Lock Set with Keys	\$ 42.00
1714 Lock Set-doors, ignition, glove, trunk	\$ 79.00
1717 Door Lock Knobs, Asst. Colors	\$ 9.00 pr
1720 Impala Interior Door Handle	\$ 18.00
1721 Impala Vent Window Crank	\$ 18.00
1722 Impala Window Crank	\$ 18.00
1723 Impala Interior Handle Set - 8 pieces	\$ 139.00
1724 Impala Interior Handle Chrome Ring	\$ 15.00
1725 Non-Impala Interior Door Handle	\$ 14.00
1726 Non-Impala Vent Window Crank	\$ 14.00
1727 Non-Impala Window Crank	\$ 14.00
1728L Impala Front Armrest Bezel - Left	\$ 34.00 ea.
1728R Impala Front Armrest Bezel - Right	\$ 34.00 ea
1729L Impala Front Armrest End Cap - Left	\$ 23.00 ea.
1729R Impala Front Armrest End Cap - Right	\$ 23.00 ea.
1712L Impala Front Armrest Reflector - Left	\$ 35.00
1712R Impala Front Armrest Reflector - Right	\$ 35.00
1475 Door Hinge Pin Kit	\$ 12.00 ea.
1486 Door End Mldg. Clip with Screws	
2 needed per door.	\$ 4.00 ea.
1719 Door Striker Plates	\$ 35.00 pr.
1900 Interior Door Pad Anodized Aluminum	
Impala Only, 100% Correct Reproduction	\$ 339.00

SEAT ITEMS

1925 POWER SEAT TRACK ASSEMBLY	
Complete change over kit. Easy installation.	
For all models.	\$ 649.00
1926 POWER SEAT SWITCH - IMPALA	\$ 135.00
1927 Seat Stops - 4 stops with screws	\$ 10.00
2926 Seat Adjustment Knob	\$ 18.00

FLOOR ITEMS

1922 Sill Plates w/correct "Body by Fisher" insert	
2 door models only	\$ 109.00
9020L Wire Protector (under carpet) Left	\$ 38.00
9020R Wire Protector (under carpet) Right	\$ 38.00

DOME LIGHT

1945 Impala Dome Lens	\$ 15.00 pr.
2945 Impala Dome Light Bezel	\$ 34.00
2945S Impala Dome Light Lens & Bezel	\$ 38.00 ea
1946 Dome Lens - Non-Impala	\$ 8.00
2946 Dome Light Bezel Non-Impala	\$ 12.00
2947 Dome Light Bulb	\$ 2.00
2948 Dome Light Switch - Door Jamb	\$ 18.00 ea.

**FOR GROMMETS OR RUBBER ITEMS
REFER TO THE WEATHERSTRIP PAGE**

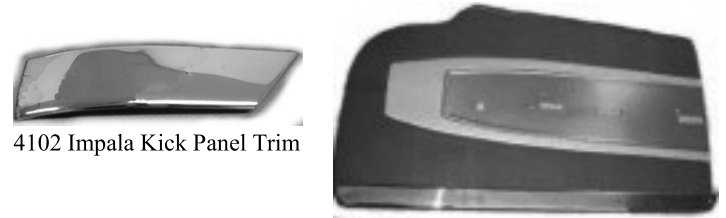

4102 Impala Kick Panel Trim

4101 Impala Lower Dr Trim



1900



3617RH Armrest Only



3616 Armrest Complete



1729



1728 Armrest Bezel



1712 Armrest Reflector



1714 Lock Set



1720 Imp Int Dr Handle



1722 Imp Window Crank

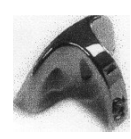

2926



1724



1721 Imp Vent Crank



1927



1926



9020

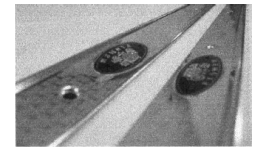

1922



2945S Imp. Lens & Bezel Set



1946

If you don't see what you need, give us a call. 800-828-2212

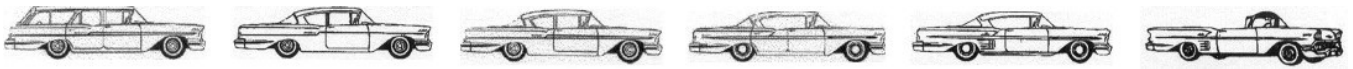

PRE-ASSEMBLED SIDE PANELS

Doors and quarter trim panel come completely assembled except for chrome & anodized trim. Ready to install with nails welded to the metal edge door bands. Includes front & rear armrest covers, 4 pc. windlace set, and colored kick panels to match your interior.

IMPALA HARDTOP - \$749.00 CONVERTIBLE - \$749.00

- | | |
|-------------------------|-------------------------|
| 6031 Black/Silver/Turq | 6038 Black/Silver/Turq. |
| 6032 Green/Silver/Green | 6039 Green/Silver/Green |
| 6033 Blue/Silver/Blue | 6040 Blue/Silver/Blue |
| 6034 Turq/Silver/Black | 6041 Turq/Silver/Black |
| 6036 Red/Silver/Black | 6037 Red/Silver/Black |
| 6035 Gold/Beige/Copper | 6042 Gold/Beige/Copper |
| 6569 Coral/Coral/Coral | 6570 Coral/Coral/Coral |

BEL AIR

Doors and quarter trim panels come completely assembled, except for anodized trim, dielectrically hit on new boards using Seville and Haircell vinyls and are ready to install with nail fasteners and new metal edge door bands. The set includes both the front armrest yardage and pre-sewn rear armrest covers, colored kick panels and pre-sewn windlace set.

2 DR. HARDTOP - \$ 699.00 4 DR. HARDTOP - \$749.00

- | | |
|-------------------------------|-------------------------------|
| 239 Silver | 252 Silver |
| 240 Green | 253 Green |
| 241 Blue | 254 Blue |
| 242 Turquoise | 255 Turquoise |
| 243 Gold | 256 Gold |
| 244 Coral | 257 Coral |
| 2 DR. SEDAN - \$739.00 | 4 DR. SEDAN - \$739.00 |
| 245 Silver | 258 Silver |
| 246 Green | 259 Green |
| 247 Blue | 260 Blue |
| 248 Turquoise | 261 Turquoise |
| 249 Gold | 262 Gold |
| 250 Coral | 263 Coral |

Biscayne 2 Door... Most Colors Available Call

NOMAD WAGON - SPECIAL ORDER - Call
NO RETURNS ON SPECIAL ORDER ITEMS

HEADLINERS

IMPALA 2 DOOR HARDTOP - \$ 199.00

Sewn perforated vinyl. Ready to install with extra material for the sunvisors.

- | | |
|------------------|----------------|
| 5898 Silver | 5899 Beige |
| 5900 Silver Blue | 7947 Turquoise |
| 7946 Green | |

BEL AIR 2 & 4 DOOR HARDTOP - \$ 169.00

Sewn perforated vinyl. Ready to install with extra material for the sunvisors. Done in 1957 colors

- | | |
|------------|---------------|
| 265 Silver | 269 Beige |
| 267 Blue | 268 Turquoise |
| 266 Green | |

BEL AIR 2 & 4 DOOR SEDAN - \$ 149.00

Pre-sewn using C.A.R.S. exclusive original type woven Dobey cloth. Ready to install with extra material for the sunvisors & upper posts.

- | | | |
|-----------|----------------|------------|
| 6340 Gray | 6351 Turquoise | 7877 Beige |
| 2879 Gold | 7876 Blue | |

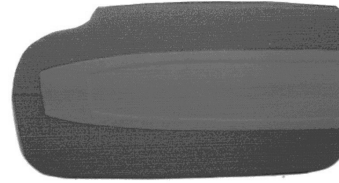

Impala Dr. Panel

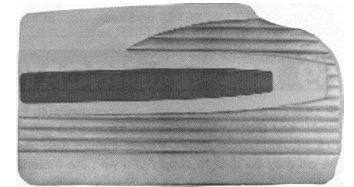

Bel Air Dr. Panel



4101 Impala Lower Dr Trim



1234 Sun Visor Brkt



1900

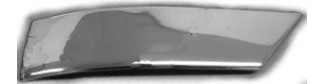

4102 Impala Kick Panel Trim

MISCELLANEOUS TRIM - IMPALA

- 1900 Door Pad Anodized Aluminum. 100% Correct \$339.00
Specify Color & Hardtop or Convertible when ordering
RED - TURQUOISE - BLUE - GREEN - GOLD - CORAL
4101 Impala Interior Dr Pad Lower Stainless Trim \$ 89.00 ea
4102 Impala Kick Panel Lower Stainless Trim \$ 49.00 ea
4119 Kick Panel Black - Blue - Turq - Green - Red \$ 22.00 ea.

SUNVISORS

Pre-sewn on new boards with correct materials.

IMPALA HT - \$ 159.00 pr.

- | | | |
|-------------|----------------------|------------|
| 6058 Silver | 8118 Light Green | 8114 Beige |
| 8127 Blue | 8117 Light Turquoise | |

IMPALA CONVERTIBLE - \$ 159.00 pr.

- | | | |
|---------------------|-------------|----------------|
| 8100 Red | 8122 Black | 8125 Dark Blue |
| 8123 Dark Turquoise | 4564 Silver | 6059 Gold |
| 8124 Dark Green | 8121 Coral | |

BEL AIR 2 & 4 DOOR HARDTOP - \$ 159.00 pr.

- | | | |
|------------|----------------|------------|
| 8137 Beige | 8134 Silver | 8138 Green |
| 8136 Blue | 8135 Turquoise | |

BEL AIR 2 & 4 DOOR SEDANS - \$ 159.00 pr.

- | | |
|------------|----------------|
| 8143 Beige | 4743 Gold |
| 8144 Gray | 8147 Turquoise |
| 8145 Blue | |

BRACKETS

- | | |
|---------------------------------------|--------------|
| 1234HTL Hardtop Sunvisor Bracket LH | \$ 33.00 |
| 1234HTR Hardtop Sunvisor Bracket RH | \$ 33.00 |
| 1234HT Hardtop Sunvisor Bracket Set | \$ 60.00 pr. |
| 1234L Convertible Sunvisor Bracket LH | \$135.00 |
| 1234R Convertible Sunvisor Bracket RH | \$135.00 |
| 1234C Convertible Sunvisor Set | \$268.00 |

PACKAGE TRAYS

- 908 Black - Green - Blue - Turquoise - Coral - Gold \$ 25.00

CALL FOR INTERIOR PACKAGE PRICES



SEAT COVERS

Pre-sewn seat covers using correct grain vinyl & multi-colored striped cloth. Set includes covers for the front & rear seats and pre-sewn rear center armrest. NOTE: Convertible seats come with reproduction vinyl inserts.

HARDTOP - IMPALA - \$899.00

- 2804 Black
- 2805 Green/ Silver/Green
- 2809 Red/Silver/Black
- 2810 Coral/Coral/Coral
- 2807 Turquoise/Silver/Black
- 2806 Blue /Silver/Blue
- 2808 Gold/Beige/Copper

CONVERTIBLE - IMPALA - \$899.00

- 2811 Black/ Silver/Turquoise
- 2814 Turquoise/Silver/Black
- 2813 Blue /Silver/Blue
- 2817 Coral/Coral/Coral
- 2816 Red/Silver/Black
- 2812 Green/ Silver/Green
- 2815 Gold/Beige/Copper

BEL AIR 2 & 4 DOOR HARDTOP - \$699.00

- 215 Silver 2 Dr.
- 216 Green 2 Dr.
- 217 Blue 2 Dr
- 218 Turq 2 Dr.
- 219 Gold 2 Dr.
- 220 Coral 2 Dr
- 221 Silver 4 Dr.
- 222 Green 4 Dr.
- 223 Blue 4 Dr.
- 224 Turq. 4 Dr.
- 225 Gold 4 Dr.
- 226 Coral 4 Dr.

BELAIR 2 & 4 DR SEDANS & NOMAD WAGON - \$729.00

- 227 Silver 2 Dr.
- 228 Green 2 Dr.
- 229 Blue 2 Dr.
- 230 Turq. 2 Dr.
- 231 Gold 2 Dr.
- 232 Coral 2 Dr.
- 233 Silver 4 Dr.
- 234 Green 4 Dr.
- 235 Blue 4 Dr.
- 236 Turq. 4 Dr.
- 237 Gold 4 Dr.
- 238 Coral 4 Dr.

Biscayne 2 Door... Most Colors Available Call

IMPALA ARMREST - Reproduction with original looking vinyl type grain and stitching. Ready to add the original lens, bezel chrome end cap. Available in black which accommodates most cars and is also easy to cover if you need another color.

- 3617R Impala Armrest Only Right Side \$ 99.00
- 3617L Impala Armrest Only Left Side \$ 99.00
- 3617P Left & Right Pair \$ 189.00
- 3616R Impala Armrest with bezel,reflector & end cap RH \$ 189.00
- 3616L Impala Armrest with bezel,reflector & end cap LH \$ 189.00
- 1728R Impala Front Armrest Bezel RH \$ 34.00
- 1728L Impala Front Armrest Bezel LH \$ 34.00
- 1729R Impala Front Armrest End Cap RH \$ 23.00
- 1729L Impala Front Armrest End Cap LH \$ 23.00
- 1712R Impala Front Armrest Reflector - RH \$ 35.00
- 1712L Impala Front Armrest Reflector - LH \$ 35.00



IMPALA - TRIM COMBINATIONS

Hardtop	Convertible
806	807 Black/Silver Turquoise Cloth/Black Vinyl
815	817 Green/Silver/Green Cloth/Green Vinyl
826	827 Blue/Silver/Blue Cloth/Blue Vinyl
836	837 Turquoise/Silver/Black Cloth/Turquoise Vinyl
847	848 Gold/Beige/Copper Cloth/Gold Vinyl
854	855 Red/Silver/Black Cloth/Red Vinyl
861	862 Coral/Coral/Coral Cloth/Coral Vinyl



Impala

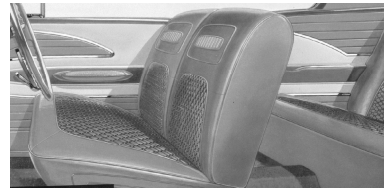

Bel Air



Floor mat

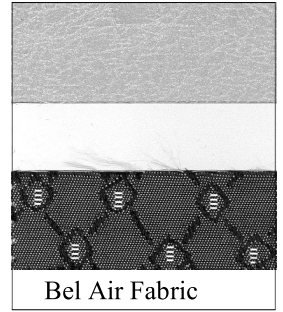
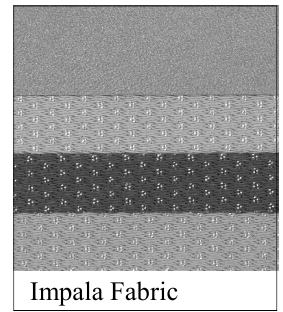

FLOOR MATS - Exact Duplicat of Original

DELUXE RUBBER MATS - 4 Pc Set LOOKS GREAT

- 2861R Red Call
- 2861B Black Call
- 2861T Turquoise Call

CARPET MATS - 4 pc - \$149.00

- 8813 Black
- 8817 Copper
- 8816 Green
- 8818 Red
- 917 Gold
- 918 Coral
- 8814 Blue
- 8815 Turquoise
- 819 Charcoal

CARPETS

IMPALA HARDTOP & CONVERTIBLE - \$199.00 - \$249.00

Complete set sewn wiorrect binding & heel pad; includes jute underlay & dimmer switch grommet. Specify hardtop or convertible.

- 2856 Red \$199
- 2851 Black \$199
- 2855 Gold \$249
- 2854 Turquoise \$199
- 2852 Green \$199
- 4741 Coral \$249
- 2853 Blue \$199

BEL AIR Complete set sewn nylon loop with correct binding & heel pad; includes jute underlay & dimmer switch grommet.

Specify exact model

2 DR. HARDTOP

- 215C Charcoal \$275.00
- 216C Green \$275.00
- 217C Blue \$275.00
- 218C Turquoise \$275.00
- 219C Gold \$275.00
- 220C Coral \$275.00

4 DR. HARDTOP

- 221C Charcoal \$275.00
- 222C Green \$275.00
- 223C Blue \$275.00
- 224C Turquoise \$275.00
- 225C Gold \$275.00
- 226C Coral \$275.00

2 DR. SEDAN

- 227C Charcoal \$275.00
- 228C Green \$275.00
- 229C Blue \$275.00
- 230C Turquoise \$275.00
- 231C Gold \$275.00
- 232C Coral \$275.00

4 DR. SEDAN

- 233C Charcoal \$275.00
- 234C Green \$275.00
- 235C Blue \$275.00
- 236C Turquoise \$275.00
- 237C Gold \$275.00
- 238C Coral \$275.00

SEAT BELTS - FRONT & REAR

2800 Many colors available

\$ 40.00 per person

800-828-2212

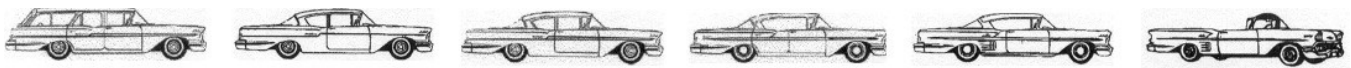

POWER WINDOW ASSEMBLIES

These are complete & exact reproductions of original GM regulators.
Including wire harness, conduits, correct switches & instructions.

1601	3 Year Warranty Easy to Install Specify Model	\$ 879.00
1602	Door Regulators - Power	\$ 125.00 ea
1603	Hardtop Quarter Regulators - Power	\$ 125.00 ea
1604	Convertible Quarter Regulators - Power	\$ 125.00 ea
1605	MOTORS NEW!!	\$ 75.00
1606	FOUR BUTTON SWITCH	\$ 99.00
1607	SINGLE BUTTON SWITCH	\$ 50.00 ea
5809	2 BUTTON SWITCH - 2 Dr Wag, Sed Delivery	\$ 90.00
1608	CONDUITS for Wiring Harness	\$ 52.00 pr
1609	WIRING HARNESS 4 Dr Set	\$ 149.00

NEW! POWER VENT WINDOW KIT NEW!

Very Easy Installation - Bolts to original holes, NO drilling

Kit includes: Motor, Gear, Conduits, Wiring, Switches & Instructions.

PV5964	A Custom Option	\$ 349.00 Pr
--------	-----------------	--------------

WINDSHIELDS - Clear or Original Tint

1610	Impala Hardtop & Convertible	\$ 299.00
1612	All other Hardtops, Sedans & Wagons	\$ 299.00

BACK GLASS - clear, orig. green, & custom grey

1613	Impala Hardtop	\$ 299.00
1613A	All Others except Impala and Wagon	\$ 299.00

SIDE GLASS - clear, orig. green & custom grey

1614	Vent Glass - All Models	\$ 25.00
1615	Door Glass - All Models	\$ 55.00
1616	Quarter Glass - All Models	\$ 55.00

SIDE GLASS PACKAGES - All Models, 6 Pieces

1617	2 Vents, 2 Doors, 2 Quarter Glasses - Any Color	\$ 239.00
------	---	-----------

VENT GLASS ASSEMBLY

3618	New vent frame & new glass	\$ 90.00 ea
------	----------------------------	-------------

VENT GLASS POST ASSEMBLY - Exchange Only

3620R	Vent Glass Assy.RH (3618) installed in Vent Post	\$399.00 ea
3620L	Vent Glass Assy LH (3618) installed in Vent Post	\$399.00 ea

DOOR GLASS ASSEMBLY

Includes new window frame, lower track & glass. Fully assembled.

1618	Convertible & Hardtop Ready to Install	\$189.00 ea
------	--	-------------

QUARTER GLASS ASSEMBLY - When Stock is Available

New window frame, re-chromed lower track & glass assembled.

1623	Impala Hardtop EXCHANGE ONLY	\$399.00 ea
1624	Impala Convertible EXCHANGE ONLY	\$399.00 ea

ASSEMBLED SIDE GLASS SET

Fully assembled, 2 vents, 2 drs. & 2 qtrs . Ready to install. The easy way to go. Exchange needed on lower quarter channel & vents.

2617	All 6 pieces Convertible \$1,050.00 Hardtop	\$1,250.00
------	---	------------

FRAMES & CHANNELS - Exact Reproductions

3621R	Vent Frame New..... Impala Only RH	\$ 65.00 ea
3621L	Vent Frame New Impala Only LH	\$ 65.00 ea
1621L	Upper Door Frame Impala HT - Left (Driver's)	\$ 89.00 ea
1621R	Upper Door Frame Impala HT - Right (Passenger)	\$ 89.00 ea
1622	Upper Door Frame Impala Convertible Rt or Left	\$ 89.00 ea
1625L	Upper Door FrameBel Air HT - Left (Driver's)	\$ 85.00 ea
1625R	Upper Door Frame Bel Air HT - Right (Passenger)	\$ 85.00 ea

Lower Door channels for all 2 Dr. Ht, Convertible & 2 Dr. Sedans

1619L	Lower Door Channel Left Side (Driver's)	\$ 79.00 ea
1619R	Lower Door Channel Right Side (Passenger)	\$ 79.00 ea
1227	Upper Quarter Frame - Convertible Left or Right	\$ 89.00 ea
1620	Upper Quarter Frame - Hardtop Left or Right	\$ 89.00 ea
5819L	2 Door Sedan Lower Door Channel LH	\$ 39.00 ea
5819R	2 Door Sedan Lower Door Channel RH	\$ 39.00 ea



DATE CODING AVAILABLE



FOR GASKETS & SEALS SEE THE WEATHERSTRIP PAGE 23

CALL 800-828-2212



BATTERY & BATTERY ITEMS

- 4114 Tar Topper Battery Cover \$ 39.00
Molded Polymer reproduction of original tar top style.
Use this with your modern battery to give it the original look.
- 2502 Battery Tray \$ 36.00
- 2503 Battery Top Retainer \$ 8.00
- 2504 Retainer Bolts - Exact Reproduction \$ 6.00 pr



BATTERY CABLES

CABLES HAVE CORRECT MARKINGS
"N" & "P" CAST ON CABLE END.

- 2526 Negative Cable - Small Block \$ 48.00
- 2527 Positive Cable - Small Block \$ 48.00
- 2529 Positive Cable - 348 \$ 48.00
- 2530 Negative Cable - 348 \$ 58.00

HARNESSES

- 50115 Park Lamp Harness \$ 58.00
- 40105 Engine Harness - 6 Cyl. Standard \$ 99.00
- 40110 Engine Harness - 6 Cyl. Automatic \$ 75.00
- 40123 Engine Harness - 283 Standard \$ 69.00
- 40122 Engine Harness - 283 Automatic \$ 75.00
- 40125 Engine Harness - 348 Standard \$ 69.00
- 40130 Engine Harness - 348 Automatic \$ 75.00
- 40135 Engine Jumper Wire - 348 Only \$ 25.00
- 25001 Overdrive Harness \$ 51.00
- 25000 Alternator Conversion Harness Kit \$ 185.00
- 89483 Wiper Motor Harness \$ 20.00
- 30105 Dash Harness with Fuse Box \$ 349.00
- 50114 Front Light Harness-V8- stk generator \$ 98.00
- 50110 Front Light Harness-6cyl stk generator \$ 98.00
- 35590PI Front Headlight Conversion
Harness with Alternator \$ 185.00
- 58001 Headlight Connection Harness
Set of 2 (does both headlights) \$ 55.00
- 80165 Taillight Harness - Impala Conv. \$ 159.00
- 80170 Taillight Harness - Impala Ht. \$ 161.00
- 80150 Taillight Harness - Bel Air & Biscayne \$ 161.00
- 80155 Taillight Harness - Delray \$ 139.00
- 1609 Power Window Harness \$ 149.00
- 2541 Taillight Pigtail with socket \$ 12.00 ea.
- 2542 Back Up Light Pigtail with socket \$ 12.00 ea.
- 2532 Ground Wire Strap Kit \$ 19.00
- 08490 Dome Light Harness - Non-Impala \$ 25.00
- 38129 Dome Light Harness - Impala \$ 39.00
- 81056 Air Conditioning Harness \$ 136.00
- 88917 Clock Harness \$ 25.00
- 89484 Power Lead Wire - for power convert.
tops, seats & windows \$ 12.00
- 38179 Gas Tank Sending Unit Ground Strap \$ 20.00



Park Light

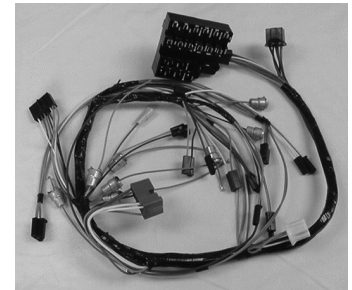

Dash with Fuse Box



Engine - 283



Front Light V8



Taillight - Impala Conv.



Headlight Connection

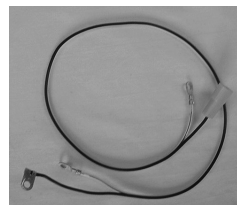

Gas Tank Sending
Unit Ground Strap



Ground Wire Straps

800-828-2212

If you don't see what you need, give us a call.



POWER DISC BRAKE CHANGEOVER KITS

B-40 Original - Complete Set Includes:

- 1 Booster with Dual Master Cylinder & Bracket
With adjustable rod with clevis
- 2 Drilled & Slotted Rotors - no extra charge
- 2 Calipers with pads 2 Hoses
- 2 Seals 2 Dust Caps
- Set of Brackets with hardware
- Roller Bearings Mounting Bolts

B-40N No Offset Stock Tracking Kit Lower Kit

B-40L Lower Disk Brake Changeover
(Same a B40 Less booster and Master cylinder)

B-40R Rear Disk change Over Kit
Includes drilled & slotted rotors

B-75-F Front Drilled/Slotted Rotor

B-75-R Rear Drilled/Slotted Rotor

DELUXE BRAKE OVERHAUL KIT

- B-1D \$379.00
- 1 New Master Cylinder Manual 2 New Rear Wheel Cylinders
- 2 Front Wheel Cylinder Rebuild Kits 3 Rubber Hydraulic Hoses
- Front & Rear Brake Shoes 1 Set of Front & Rear Brake Springs & Hdw.

STANDARD BRAKE OVERHAUL KIT

- B-1S \$299.00
- 2 Front Wheel Cylinder Rebuild Kits 3 Rubber Hydraulic Hoses
- 2 Rear Wheel Cylinder Rebuild Kits Front & Rear Brake Shoes
- 1 Set of Front & Rear Brake Springs & Hardware

POWER BRAKE BOOSTER, MASTER CYLINDER & BRACKET

- B-42 7" Booster with Dual Master Cylinder & Mounting Bracket
with adjustable rod and clevis. \$149.00
- B-42C 7" Chrome Dual Booster with Master Cylinder, Mounting
Bracket & adjustable rod with clevis \$199.00

POWER BRAKE BOOSTER ONLY

- B-41 7" Standard Single Booster \$ 99.00
- B-41D 7" Dual Booster. \$ 109.00
- B-41-9 9" Booster \$129.00
- B-41C 7" Chrome Dual Booster \$139.00
- B-33 Tredle Vac Power Brake Booster Rebuild Kit \$ 99.00

MASTER CYLINDERS

- B-1 Manual Master - Orig. Style Single Reservoir \$ 70.00
- B-60 Dual Master Cylinder - Power or Manual \$ 69.00
- B-60C Chromed Master Cylinder - Power or Manual \$ 89.00

WHEEL CYLINDERS

- B-5L Front Cylinder - Left New Available \$ 50.00
- B-5R Front Cylinder - Right New Available \$ 50.00
- B-6L Rear Wheel Cylinder - Left \$ 26.00
- B-6R Rear Wheel Cylinder - Right \$ 26.00



B-40

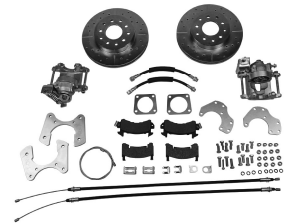

B40R

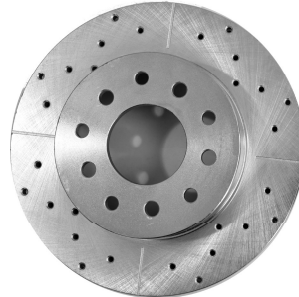

B-75-R Rear Drilled & Slotted Rotor



B-75-F Frt. Drilled/Slotted Rotor



B-1D Deluxe Overhaul Kit



B-42 7" Booster/Master



B-42C 7" Chrome Booster/Master



B-41



B-60C Chrome Master Cyl



B41-D with Chrome



B-60 Dual Master Cyl.



B41-9 with Chrome



B-1 Orig. Single Master



B-41D 7" Dual Booster

**If you don't see what you need,
give us a call. 800-828-2212**



BRAKE ITEMS

B-8	Front Brake Hose (left & right same)	\$ 20.00
B-9	Rear Brake Hose	\$ 19.00
B-51	Front & Rear Hose Clip Set	\$ 4.00
B-52	Hose Bracket - 283 (at the valve cover)	\$ 15.00
B-53	Hose Bracket - 348 (at the valve cover)	\$ 11.50
B-10	Front Drum - New	\$ 60.00
B-11	Rear Drum - New	\$ 60.00
B-12	Front Shoes	\$ 35.00
B-13	Rear Shoes	\$ 35.00
B-14	Front Brake Hardware Kit - Both Sides	\$ 34.00
B-15	Rear Brake Hardware Kit - Both Sides	\$ 34.00
B-43	Power Brake Booster Mounting Bracket	\$ 39.00
B-55	Proportioning Valve	\$ 49.00
B-44	Proportioning Valve with Bracket & lines	\$ 65.00
B-45	Proportioning Valve Bracket	\$ 18.00
B-46	Proportioning Valve Lines to Master	\$ 18.00
B-57	Proportioning Valve - adjustable	\$ 49.00
B-58	Disc Brake Bracket Kit	\$ 149.00
B-50	Drop Spindles (2 Inch Drop)	\$ 299.00
B-30	Pwr Brake Vacuum Hose & Clamps- need 2	\$ 9.00 ea
B-31	Brake Drum Spring	\$ 7.00
B-73	Electric Vacuum Pump - for Power Booster	\$ 199.00
	Includes mounting hardware, hose, switch & wiring.	
	Maintains 18-22 PSI	



B-8

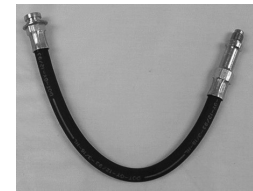

B-9



B-13



B-15 Rear Brake Hardware



B-73 Electric Vacuum Pump

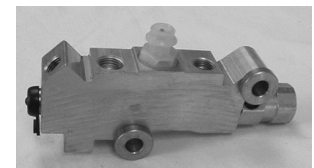

B-55 Proportioning Valve

EMERGENCY BRAKE ITEMS

B-17	Front Cable	\$ 17.00
B-18	Center Cable	\$ 19.00
B-19	Rear Cable (2 needed)	\$ 19.00 ea.
B-20	Brake Cable Roller	Set \$ 9.00
B-21	Brake Cable Boots	\$ 6.00 pr.
B-62	Equalizer Assembly - not convertible	\$ 38.00
B-62C	Equalizer Assembly - Convertible	\$ 40.00
B-63	Brake Clevis	\$ 12.00
B-64	Forward Roller Bolt Set	\$ 5.00 pr.
B-65	Rear Cable Connector - replacement	\$ 1.00
B-66	Rear Cable Connector - Stainless	\$ 11.00
B-67	Brake Cable Clips	\$ 2.00 pr.
B-68	Emergency Brake Pedal Pad	\$ 5.00
B-69	Emergency Brake Release Handle	\$ 19.95



B-58 Disc Brake Bracket Kit

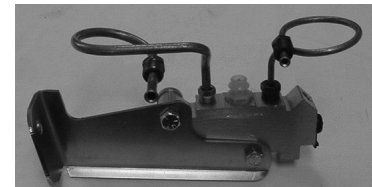

B-44 Prop. Valve, Brkt & Lines

BRAKE LINES

B-22	7 pieces without power brake	Set \$ 124.00
B-23	7 pieces with power brake	Set \$ 124.00
B-24	7 pieces without power brake Stainless	Set \$ 189.00
B-25	7 piece with power brake, Stainless	Set \$ 189.00
B-26	Front Lines without power brake	\$ 45.00 ea.
B-27	Front Lines with power brake	\$ 45.00 ea.
B-28	Center Brake Line	\$ 44.00 ea.
B-29	Rear Axle Housing Line	Set \$ 32.00



B-50 Drop Spindles

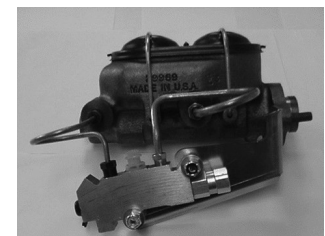

Proportioning Valve with Dual Master Cyl. Attached

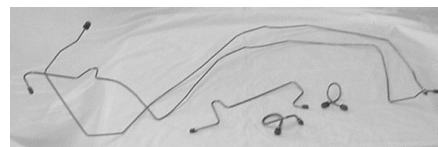

Brake Lines

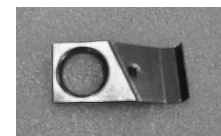

B53 348 Hose Brkt



B69

ORDERING IS EASY!

CALL 800-828-2212



GAS TANK & RELATED ITEMS

118	Reproduction steel tank w/filler neck	\$199.00
118SS	Stainless Steel Tank - New	\$499.00
1500L	Left Trunk Floor Tank Support Brace	\$ 85.00
1500R	Right Trunk Floor Tank Support Brace	\$ 85.00
1501	Gas Tank Strap, Pads & Correct Bolts	\$ 59.00
1502	Gas Filter	\$ 5.75
1502A	Fuel Strainer - Filter (sock)	\$ 8.00
1503	Glass Fuel Bowl With Filter (#1502)	\$ 32.00
1504	Gas Cap (Anti Surge Vented)	\$ 10.00
1504A	Fuel Door Return Spring	\$ 4.00
1505	Gas Pedal - Rubber	\$ 12.00
1505A	Gas Pedal to Floor Stud - 2 needed	\$ 5.00 pr.
1506	Gas Tank Sending Unit 5/16" or 3/8"	\$ 45.00
1506W	Gas Tank Sending Unit - Station Wagon	\$ 95.00
1507	Gas Tank Sending Unit Gasket	\$ 1.50
2074	Gas Door Bumpers	\$ 1.65 pr.
38179	Gas Tank Sending Unit Ground Strap	\$ 20.00
4111	Fuel Gauge - NEW Reproduction	\$ 89.95



118

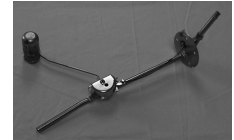

1506 Sending Unit



1500 Trunk Floor Tank Support



38179



1501 Gas Tank Straps, Pad & Bolts



1503

FUEL PUMPS

1508	Fuel Pump Adapter - Dual Action 348,3x2	\$ 75.00
1509	348, 3 x 2 AC Fuel Pump with Vacuum Assist Original NOS	\$ 175.00
1510	348 - 4 BBL Pump 3x2 w/o Vacuum Assist	\$ 60.00
1511	283 Original Style Pump	\$ 50.00



4111 Fuel Gauge



1509 Fuel Pump



1508 Fuel Pump Adapter

FUEL LINES

TANK TO PUMP

1512	All 348, 283 4BBL - 3 pieces 3/8"	\$ 75.00
1512S	283 2 BBL - 1 piece 5/16"	\$ 99.00
1515	348 3/8" Line Clamp Set - 4 pcs.	\$ 2.50

PUMP TO CARB

1541	348, 3 x 2 with vacuum assist (early)	\$ 60.00
1542	348 4BBL	\$ 20.00

FUEL LINES TO CARBS

1514	348, 3 x 2 Carb to Carb to Carb 3 pc	\$ 70.00
------	--------------------------------------	----------



1505A

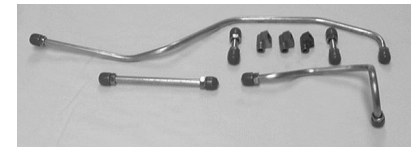

1514 Fuel Lines to Carbs

CARBURETOR REBUILD KITS

1518	Carter 4BBL	\$ 39.00
1519	Rochester 4 BBL	\$ 39.00
1520	Rochester 2 BBL	\$ 39.00

CARBURETOR MISC.

1521	Choke Tube - 348 3 x 2	\$ 17.00
1522	Choke Tube - 283 4 BBL	\$ 10.00
1523	Choke Tube - 2BBL	\$ 10.00
1524	Carburetor Vacuum Stud Bolt	\$ 11.00
1532	348, 3 x 2 Throttle Linkage Rods & Clips	\$ 34.00
1536	348, 3x2 Progressive Linkage Rods & Clips	\$ 79.00
1533P	Lower Carb Kick Down Rod - Powerglide	\$ 23.00
1534	Upper Carb Linkage Rod	\$ 29.00
1535P	Upper Carb Kick Down Rod - Powerglide	\$ 18.00
1537P	Carb Kick Down Linkage Bracket Assbly.	\$ 88.00
1538	Throttle Return Spring	
	(Specify engine size & Carb)	\$ 8.00
1539	Carb Stud Kit (specify 1" or 2")	\$ 3.25
1543	Carb to Intake Stud Kit 4BBL	\$ 11.00



1537P



1521 Choke Tube



1532



1536

If you don't see what you need, give us a call.

800-828-2212



MANY GOOD USED MOTORS IN STOCK
348 - 283 - 6 Cyl.

MISCELLANEOUS MECHANICAL PARTS

1404	Camshaft - 348 New Hydraulic	\$329.00
1408	Gasket Set - 348	\$279.00
1410	Hydraulic Lifters - 348 Set	\$ 79.00
1412	Main Bearings - 348 -10, -20	\$199.00
1414	Oil Pump - 348	\$ 65.00
1416	Oil Pump Drive Shaft - 348	\$ 25.00
1418-A	Pistons - 348 - 9.5:1 +30, +40, +60 Set	\$349.00
1418-B	Pistons - 348 - 10.5:1 +30, +40, +60 Set	\$449.00
1418S-A	Single Piston - 348 9.5:1 +30, +40, +60	\$ 49.00
1418S-B	Single Piston - 348 10.5:1 +30, +40, +60	\$ 59.00
1420	Piston Rings - 348 Cast +30, +40, +60	\$ 99.00
1422	Piston Rings - 348 Moly +30, +40, +60	\$149.00
1423	Rocker Arm - 348 Bowl & Nut Assbly (16 pcs.)	\$219.00
1424	Rocker Arm - 283 Bowl & Nut Assbly (16 pcs.)	\$189.00
1425-A	Rear Main Seal - 348 (Rope style) Set	\$ 49.00
1425-B	Rear Main Seal - 348 (Rubber style) Set	\$ 69.00
1429	Timing Chain & Gear Set - 348	\$ 69.00
1431	Rod Bearing Set - 348, -10, -20, -30 ea.	\$ 5.99
1432	Rod Bearing Set - 283 -10, -20, -30 ea.	\$ 5.99
1433	Intake Valve - 348	\$ 15.00
1434	Exhaust Valve - 348	\$ 19.00
1435	Valve Set - 348 (Intake & Exhaust, 16 pcs.)	\$259.00
1436	Intake Valve - 283	\$ 12.00
1437	Exhaust Valve - 283	\$ 13.00
1438	Valve Set - 283 (Intake & Exhaust, 16 pcs)	\$180.00
1448	Valve Springs	\$ 4.50
1439	Road Draft Tube	\$109.00
1439A	Road Draft Tube Bracke Bolt	\$ 14.00
1441	Dipstick - 283	\$ 25.50
1442	Dipstick - 348	\$ 40.00
1443	Dipstick Tube - 348	\$ 34.00
1444	Dipstick Tube - 283	\$ 35.00
1445	Breather Cap - 348 & 283	\$ 28.50
1450	Freeze Plugs - 348 - Set	\$ 39.00
1451	Oil Filter Element V8	\$ 14.00
1452	Cam Bearing Sets - 348	\$ 99.00
1453	Oil Pump Pickup - 348	\$ 40.00
1454	PR 48010 Push Rod - 348	\$ 8.50
1455	PR 48011 Push Rod - 348	\$ 8.50

TUNE - UP

1549	Spark Plug Retainer - 348 3 x 2	\$ 15.00
1550	Spark Plug Wire - 348 4BBL Set	\$ 62.00
1551	Spark Plug Wire - 348 3 x 2 Set	\$ 62.00
1552	Spark Plug Wire - 283 Set	\$ 62.00
1553	Starter Solenoid - All	\$ 20.00

TUNE - UP (cont'd)

1554	Coil - All	\$ 19.00
1554A	Coil Bracket - 348 3x2 Mounts to Firewall	\$ 25.00
1555	AC Spark Plug - 348 #44	\$ Call
1556	AC Spark Plug 283 #45	\$ Call
1557	Voltage Regulator	\$ 79.00
1558	Voltage Regulator - with Air Cond.	\$ 79.00
1559	Ignition Wire Grommet (4 hole) ea.	\$ 3.50
1560	Points - All V-8	\$ 21.00
1561	Rotors - V-8	\$ 8.50
1562	Condenser - V-8	\$ 11.00
1563	Distributor Cap	\$ 16.00
1564	Vacuum Advance Pod For Distributor	\$ 40.00
1566	Oil Pressure Switch - All Except 348	\$ 15.99
1567	Oil Pressure Switch - 348	\$ 16.99
2562	Ballast Resistor	\$ 13.00

TRANSMISSION & DRIVE SHAFT

1860PG-C1	POWERGLIDE MASTER REBUILD KIT (Gaskets/Rubber Seals/Metal Clad Seals/Sealing Rings/Rear Pump Drive Pin/Clutch and Steel Plates)	\$360.00
1860PG-C2	POWERGLIDE MAJOR REBUILD KIT (Gaskets/Rubber Seals/Metal Clad Seals/Sealing Rings/Rear Pump Drive Pin/Friction Plates)	\$204.00
1860PG-C3	POWERGLIDE OVERHAUL REBUILD KIT (Gaskets/Rubber Seals/Metal Clad Seals/Sealing Rings/Rear Pump Drive Pin)	\$147.00
1860TG-A1	TURBOGLIDE MASTER REBUILD KIT (Gaskets/Rubber Seals/Metal Clad Seals/Sealing Rings/Clutch and Steel Plates)	\$684.00
1860TG-A2	TURBOGLIDE MAJOR REBUILD KIT (Gaskets/Rubber Seals/Metal Clad Seals/Sealing Rings/Friction Plates)	\$392.00
1860TG-A3	TURBOGLIDE OVERHAUL REBUILD KIT (Gaskets/Rubber Seals/Metal Clad Seals/Sealing Rings)	\$278.00
1861	Trans Mission Mount - Auto Turboglide	\$ 12.50
1861A	Transmission Mount Powerglide	\$ 22.00
1862	Speedometer Cable - Auto	\$ 19.00
1659	Neutral Safety Switch - Auto	\$ 17.50
1869	Transmission Cooling Lines - 348	\$ 79.00
1870	Transmission Cooling Lines - 283	\$ 99.00
1871	Flywheel New replacement style Powerglide	\$ 99.00

**If you don't see what you need,
 give us a call. 800-828-2212**



EXHAUST SYSTEM

Includes pipes and mufflers. These are an exact fit, identical to NOS systems. 304 Stainless

1350	348 Dual - Stainless Steel	\$ 539.00
1351	283 Dual - Stainless Steel	\$ 539.00
1359	Muffler - Stainless Steel	\$ 85.00 ea.
1359P	Muffler - Stainless Steel - 2 Mufflers	\$169.00 pr
1359H	Muffler - Glass Pack (<i>Hollywood</i>)	\$ 45.00 ea.
1360	Cross - Over Pipe (<i>Y-Pipe</i>)	\$139.00
1361R	Exhaust Pipe - Right Side Stainless Steel	\$ 70.00
1361L	Exhaust Pipe - Left Side Stainless Steel	\$ 70.00
1383R	Tailpipe - Right Side Stainless Steel	\$ 75.00
1383L	Tailpipe - Left Side Stainless Steel	\$ 75.00

EXHAUST MANIFOLDS

6 Cylinder, 283 & 348 Exhaust Manifolds Available		Call for Price
1363	Heat Risers 2"	Call
1364	Heat Risers 2 1/2"	Call

MISC. EXHAUST PARTS

1362	Flanges - 2:	\$ 7.00 ea.
1365	Stainless Steel Clamp (SS system) 8 needed	\$ 6.00 ea.
1379	Muffler Clamp 2" (for aluminized system)	\$ 6.00 ea.
1366	Long Manifold Studs - 3 needed	\$ 1.75 ea.
1367	Short Manifold Studs - 3 needed	\$.75 ea.
1368	Manifold Brass Nut - 3 needed	\$.75 ea.
1369	Doughnut - 2"	\$ 2.50
1370	Dual Exhaust Bracket	\$ 15.50
1372L	Front - Left Muffler Hanger	\$ 24.00
1372R	Front - Right Muffler Hanger	\$ 24.00
1374L	Front - Left Exhaust Hanger	\$ 20.00
1374R	Front - Right Exhaust Hanger	\$ 20.00
1376L	Rear - Left Exhaust Hanger	\$ 20.00
1376R	Rear - Right Exhaust Hanger	\$ 20.00
1378	Complete set of Exhaust Hangers - 6	\$149.00
1380	Exhaust Gasket 2"	\$ 4.00
1381	Exhaust Gasket 2 1/2"	\$ 3.00
1382	Exhaust Manifold Bolt locks 1 Set	Call

AIR CLEANERS

TRI-POWER STEEL AIR CLEANER

EXACT REPRODUCTION! FOR 1958 CHEV ONLY

TS5861B Air Cleaner with Correct Lid - For non-air models \$599.00

For models with air conditioning Call
"Satisfaction Guaranteed"

ORIGINAL STEEL USED 2 BBL, 4BBL & 3 x2 AIR CLEANERS

4BBL & 2BBL OIL BATH AIR CLEANER COMPLETE

CALL FOR PRICE & AVAILABILITY

3606	Air Cleaner Base (includes snorkels)	\$ 500.00
1525	Steel 3x2 Lid Correct Pie Dish Style	\$ 115.00
1525S	Steel 3x2 Air Cleaner Snorkel (2 used)	\$ 60.00 ea
1525ST	3x2 Air Cleaner Stack	\$ 25.00 ea
1527	Tri-Power Air Filter	\$ 30.00
1528	Air Cleaner Wing Nut	\$ 2.00
1529	348 Air Cleaner Wing Nuts Set of 3	\$ 6.00
1530	Air Cleaner Studs 3x2 Set of 3	\$ 18.00
1531	Air Cleaner Studs 4 BBL	\$ 5.00
1544	Air Cleaner Stud 6 Cyl	\$ 6.00

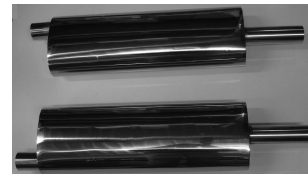

1359P



1378



1382



1372L



1374L



1370



1376L



1365



1369



1362



1380

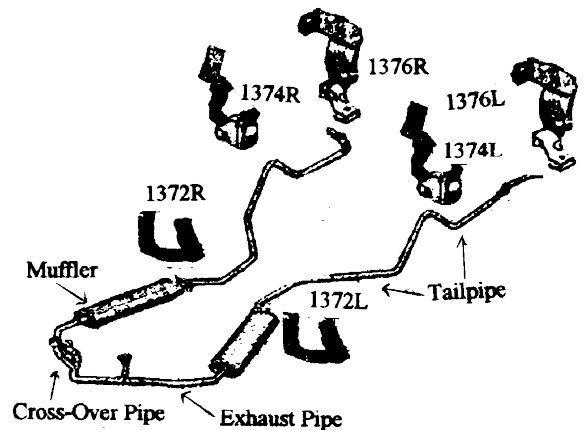

3606 STEEL



1525



1527

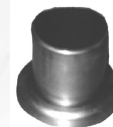

1525ST

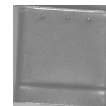

1525SA

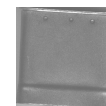

1525SB



Snorkel A B

Give us a call. 800-828-2212



AIR CONDITIONER BRACKET

Bracket with Idler Pulley Bearing. Exact & precise reproduction.

- | | | |
|-------|---------------------------|----------|
| 1569T | 348 Tri Power | \$599.00 |
| 1569B | 348 4BBL (When Available) | \$CALL |
| 1569 | 283 (When Available) | \$CALL |

Type your text

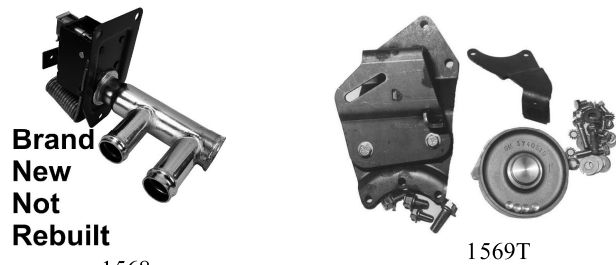

COOLING & HEATING

- | | | |
|-------|---|--------------|
| 1568 | New Heater Control Valve -Not Rebuilt | \$189.00 |
| 1568A | Heater Control Valve Block Off | |
| | Free flow aluminum replacement | \$ 49.00 |
| 1568H | Heater Control Valve Hose, 90 degree angle from valve to heater core. | \$ 18.00 |
| 1584 | Fan Belt with GM Logo | \$ 15.00 |
| 1585 | Hose Clamp Kit, Radiator & Heater | \$ 14.00 |
| 1586 | Heater Hose Set with GM Logo | \$ 29.00 |
| 1587 | By-Pass Hose - 348 3 x 2 | \$ 12.50 |
| 1594 | Water Nipple - for 5/8" hose | \$ 5.00 |
| 1595 | Thermostat | \$ 6.00 |
| 1595A | Thermostat Housing | \$ 16.00 |
| 1596 | Temperature Sending Unit | \$ 14.00 |
| 4110 | Temp Gauge - NEW Reproduction | \$ 69.00 |
| 1588 | Heater/Defroster Cable Set of 3 | \$ 49.00 |
| 1589 | Heater Seal Deluxe | Set \$ 17.00 |
| 1573 | Heater Seals from box to cowl | \$ 17.00 |
| 1574 | 348 3 x 2 By-Pass Valve | \$ 40.00 |
| 1575 | Radiator Cap | \$ 13.00 |
| 1590 | Heater Hose Clamp - Inner Fender | \$ 5.00 |
| 1591 | Defroster Air Duct Line 2" or 3" plastic | \$ 42.00 |
| 1592 | Temperature Switch | \$ 14.00 |
| 1593 | Heater By-Pass Hose Spring | \$ 4.00 |
| 3204 | Heater Core NEW | \$ 95.00 |
| 3205 | Cooling Fan w/Housing Black or Chrome | \$ 49.00 |

USED FAN SHROUDS & FANS AVAILABLE - CALL

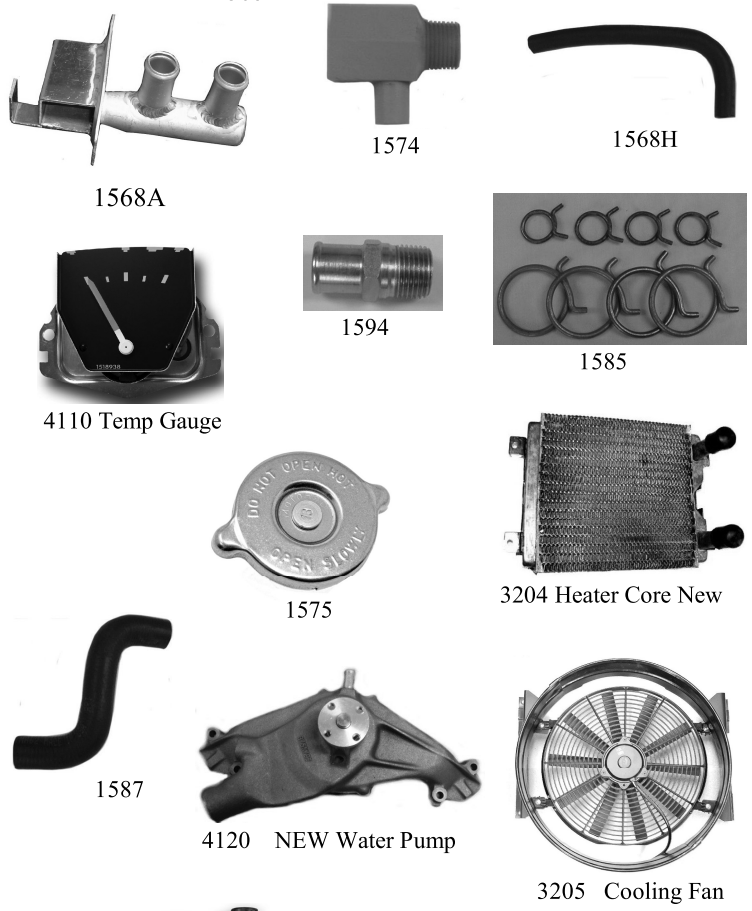

WATER PUMPS

- | | | |
|------|------------------------------|-----------|
| 4120 | New Water Pump - not rebuilt | \$ 200.00 |
|------|------------------------------|-----------|

RADIATORS - ALL HIGH EFFICIENCY

OUR NEWEST REPRODUCTION RADIATOR

- | | | |
|------|-------------------------------------|----------|
| 4115 | POLISHED ALUMINUM with fan & shroud | \$369.00 |
| 4116 | POLISHED ALUMINUM w/o fan & shroud | \$269.00 |
| 1570 | 348 Radiator Original Style | \$379.00 |
| 1571 | 283 Radiator Original Style | \$379.00 |

RADIATOR HOSES - All With GM Original Style Markings

- | | | |
|------|-------------------------|----------|
| 1576 | Upper 283 | \$ 29.00 |
| 1577 | Upper 348 3 x 2 | \$ 29.00 |
| 1578 | Upper 348 4BBL | \$ 29.00 |
| 1579 | Upper 348 4BBL with Air | \$ 29.00 |
| 1580 | Lower 348 - All Models | \$ 29.00 |
| 1581 | Lower 283 - All Models | \$ 29.00 |

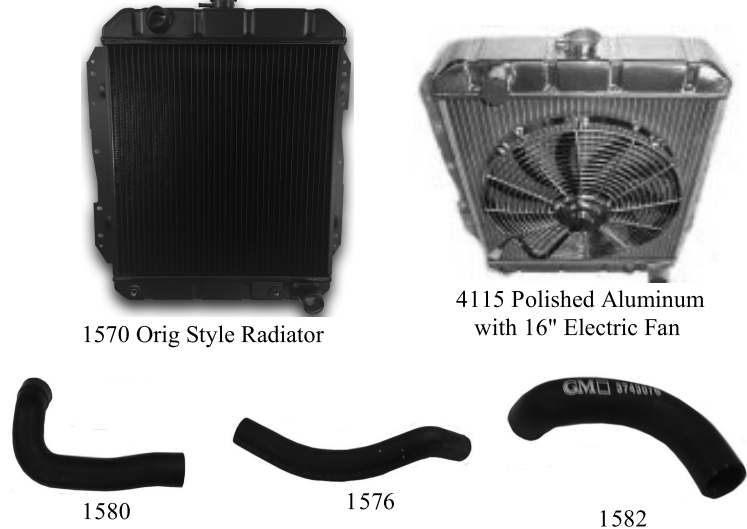

If you don't see what you need, give us a call 800-828-2212



POWER STEERING

4117	Chrome Pump, reservoir, 2 groove pulleys, cap w/dip stick	\$ 179.00
5102	Complete 500 Series Conversion Kit	\$ 649.00
Includes 500 series gear box, pump, hoses, rag joint & mounting brkt.		
5100	500 Series Style Bracket (bolts to box to frame)	\$ 59.95
5101	500 Series Gear Box w/aluminum cover	\$ 529.00
5103	500 Series Power Steering Hoses	\$ 62.00
5104	500 Series Rag Joint	\$ 45.00
5106	500 Series Style Small Block Pump Bracket	\$ 69.00
5107	500 Series Style 348 & 409 Pump Bracket	\$ 79.00
5105	500 Series Style PS Pump w/cap & pulley	\$ 169.00
4121	Lower Crank Pulley	\$ 29.00
1680	Pump Rebuild Kit - Generator Style	\$ 15.00
1682	Cylinder - New	\$ 169.00
1685	Power Steering Hose Kit, w/ Hose Foam Covers	\$ 70.00
1686	Steering Box - Complete Rebuilt Exchange	\$ 259.00
1688	New Control Valve	\$ 229.00
1689	Generator Bracket - Bolts to Manifold	\$ 27.00
1690	Generator Bracket - Bolts to Head	\$ 22.00
1691	Lower Hose Clamp - Bolts to Splash Pan 2pc.	\$ 25.00
1692	Ram Bushing Kit	\$ 8.50
1693	Generator Bracket - For Tightening Fan Belt	\$ 19.00
1694	348 Alternator Conversion Brackets	\$ 149.00
1491	Hose Retainer	\$ 25.00

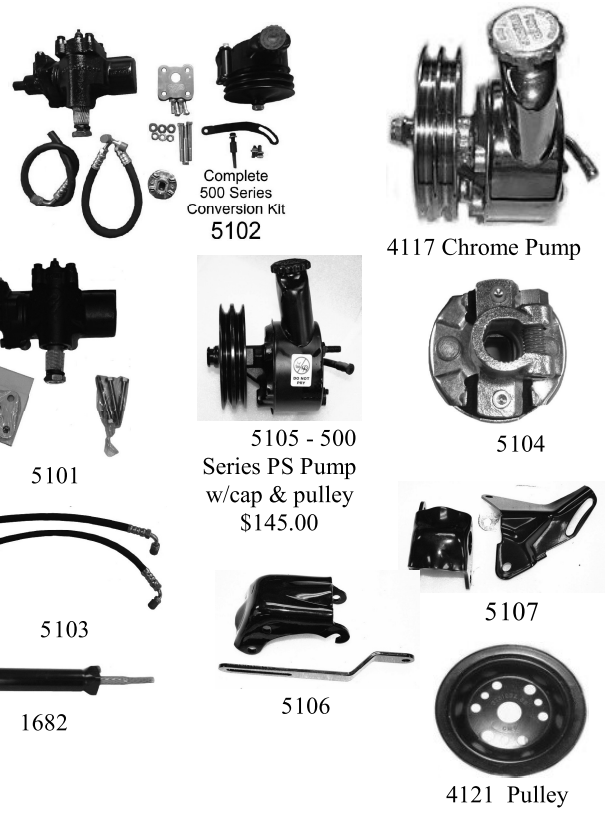

TILT COLUMNS - CUSTOM ITEM

SC7002	32" Tilt Column with column shift - Paintable	\$199.00
SC7002C	32" Tilt Column with column shift - Chrome	\$199.00
SC7002	30" Tilt Column with column shift - Paintable	\$199.00
SC7002C	30" Tilt Column with column shift - Chrome	\$199.00
SC7003	32" Tilt Column with column shift - Paintable	\$199.00
SC7003C	32" Tilt Column with column shift - Chrome	\$199.00
SC7006	30" Tilt Column with floor shift - Paintable	\$199.00
SC7006C	30" Tilt Column with floor shift - Chrome	\$199.00
SC7007	32" Tilt Column with floor shift - Paintable	\$199.00
SC7007C	32" Tilt Column with floor shift - Chrome	\$199.00
SC7010C	31" Tilt Keyed Column w/Column Shift Chrome	\$219.00
SC7011C	33" Tilt Keyed Column w/Column Shift Chrome	\$219.00
SC7014C	31" Tilt Keyed Column w/Floor Shift Chrome	\$219.00
SC7015C	33" Tilt Keyed Column w/Floor Shift Chrome	\$219.00
SC4201	Short Drop - 2"	\$ 35.00
SC4205	Tall Drop - 4"	\$ 35.00
SC4303	Wiring Adapter	\$ 35.00
SC6002A	Adapter - 9 Hole Most commonly used	\$ 20.00
SC4142	Adapter- 6 Hole Rarely Used	\$ 35.00

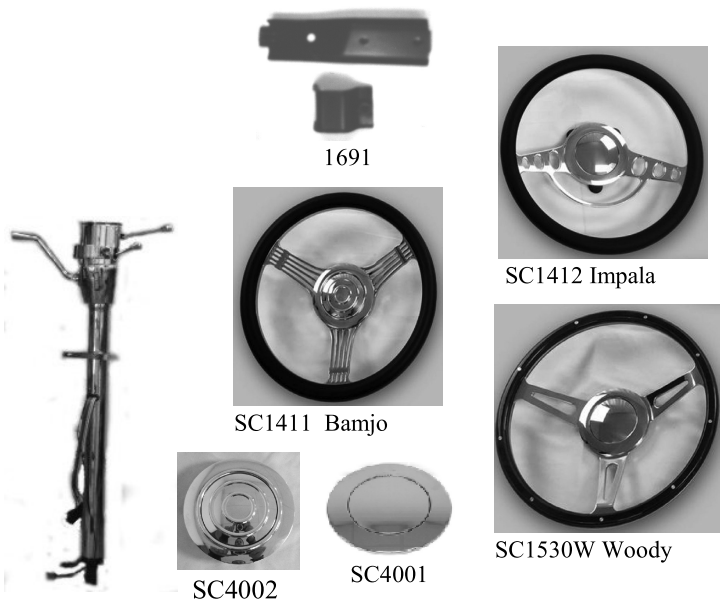

CUSTOM STEERING WHEELS Steering wheel comes with a black removable leather half wrap and includes the horn button. Additional wraps are available in red, tan, grey & wood for an additional fee. You can also color the wrap to match your car.

SC1411	14" Chrome Aluminum Wheel Banjo Style Half Wrap	\$179.00	SC4215	Swivel Mount 2 pc	\$ 38.00
SC1412	14" Chrome Aluminum Wheel Impala Style Half Wrap	\$179.00	SC4220	Planetary Mount 3 pc	\$ 38.00
SC1410	Add'L Half Wrap Red, Tan, Grey - Specify Color	\$ 15.00			
SC1410W	Additional Half Wrap Wood	\$ 20.00			
SC1430W	14" Full Wood 3 Spoke Wheel	\$179.00			
SC1431	14" Black Leather Full Wrap 3 Spoke Wheel	\$179.00			
SC1530W	15" Full Wood 3 Spoke Wheel	\$179.00			
SC4001	Center Horn Button - Smooth Look	\$ 25.00			
SC4002	Center Horn Button - Ribbed Look	\$ 25.00			



Give us a call. 800-828-2212



TIRES, WHEELS & CAPS - CALL FOR CURRENT TIRE PRICING

- 1830 B.F. Goodrich 800 x 14 - 2 1/4" Whitewalls-Correct Conv & Wag
- 1830R American classics 800 x 14 - 2 1/4" Whitewalls - Radials.
- 1831 B.F. Goodrich 750 x 14, 2 1/4" Whitewalls Correct for Ht & Sed
- 1831R American Classics 750 x 14 2 1/4" Whitewalls- Radials
- 1832 Classic Radials w/2 1/4"- 205.75 R14 & 215.75R14

**Due to frequent price changes on tires, please call for current price.
Tires may be dropped shipped from the manufacturer**

- 1834 WHEEL COVER KIT - All 12 decals needed for 4 wheel covers. Easier than painting & looks great! \$ 59.95
- 1835 Spinners w/hardware - the "Classic" look" Set of 4 \$169.00
- 1836 Lug Nuts \$ 1.00

**USED WHEELS - CALL FOR AVAILABILITY & PRICE
RESTORED WHEEL COVERS "SHOW QUALITY"**

Original 58 Chev Wheel Covers - restored with dings removed, buffed, & polished to a high shine with new spinners added- Set of 4 \$CALL

WHEEL BEARINGS, MOTOR MOUNTS, ETC.

- 1850 Drive Shaft Center Support Bearing - Original Style \$ 29.00
- 4122 Drive Shaft Center Support Bearing - NEW 1 PC ALUMINUM CAST W/POLYURETHANE INSERT. "Lifetime Warranty" \$ 79.00
- 1851 U-Joints (3 Needed) \$ 7.50 Ea
- 1852 Motor Mounts for All V-8 \$ 19.00 ea.
- 1853 Inner Wheel Bearing - Front with Race \$ 39.00
- 1854 Outer Wheel Bearing - Front with Race \$ 20.00
- 1855 Rear Wheel Bearing with Seal \$ 60.00
- 1856 Inner Front Wheel Seals \$ 6.50
- 1857 Rear Wheel Bearing Seal \$ 8.00
- 1858 Housing to Backing Plate Gasket \$ 3.00
- 1859 3rd member two housing Gasket \$ 12.95

- SUSPENSION KIT - 1801 \$179.00**
- 2 Upper Ball Joints 2 Lower Ball Joints 2 Strut Rod Bushings
 - 2 Stabilizer Links 2 Sway Bar Bushings 2 Outer Tie Rod Ends
 - 4 Upper, 4 Lower Inner Control Arm Bushings Control Arm Bumpers

SUSPENSION ITEMS

- 1804 Front Gas Shocks \$ 54.00 pr.
- 1805 Rear Gas Shocks \$ 54.00 pr.
- 1806 Coil Springs - Small Block \$129.00 pr.
- 1807 Coil Springs - 348, Convertible \$ 65.00 pr.
- 4118 Rear Lower Control Arm Set w/polyurethane bushings \$249.00
- 4123 Manual Drag Link & manual pitman arm \$ 99.00
- 1810 Outer Tie Rod End \$ 17.00
- 1811 Inner Tie Rod End \$ 27.00
- 1812 Upper Ball Joint \$ 30.00
- 1813 Lower Ball Joint \$ 25.00
- 1814 Idler Arm \$ 40.00
- 1817 Lower Inner Bushing Set \$ 33.00
- 1818 Upper Inner Bushing Set \$ 33.00
- 1819 Stabilizer Link \$ 16.00 pr.
- 1821 Upper Control Arm Bumper \$ 7.95
- 1821-L Lower Control Arm Bumper \$ 8.95
- 1822 Rear Axle bumper (2 Needed) \$ 13.95 ea
- 1820 REAR BUSHING KIT All 10 Bushings \$ 182.00
- 3607 TUBULAR A-FRAMES -Upper & Lower with bushings- Black Works with orig. equipment Set of 4 \$329.00
- 4128 Upper Control Arm Cross Shaft \$ 25.00
- 4129 Lower Control Arm Cross Shaft \$ 25.00



1830



Restored Wheel Covers Set of 4



1834

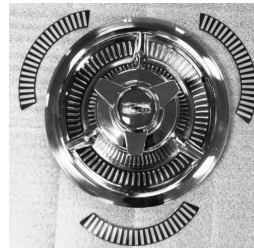

Placement of Part 1834



1835 Set of 4 Spinners



1801



4118 Rear Control Arms



4128



4129



4122 New 1Pc STRONGER

1850 Orig Style



4123



3607 Tubular A-Frames



1820



Coil Springs

ORDERING IS EASY! 800-828-2212



Floor Brace 1st from Front (22")
 9006 Left \$108.00
 9007 Right \$108.00



7750 Left Front Floor Pan
 7751 Rt Front Floor Pan
 \$110.00 ea.



7752 Left Rear Floor Pan
 7753 Rt Rear Floor Pan
 \$110.00 ea



CONVERTIBLE ONLY
 Inside Cowl Support
 9016L Left \$60.00
 9016R Right \$60.00

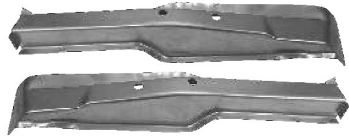

Floor Brace 2nd from Front (25")
 9008 Left \$108.00
 9009 Right \$108.00



9004 Left Toeboard \$153.00
 9005 Right Toeboard \$153.00



9020L Wire Chaser Left \$38.00
 9020R Wire Chaser Right \$38.00



Floor Brace 3rd from Front (20")
 9010 Left \$110.00
 9011 Right \$110.00



Under Seat Riser

1291HL Hardtop Left \$55.00
 1291HR Hardtop Right \$55.00
 1291CL Convertible Left \$60.00
 1291CR Convertible Rt. \$60.00



9018 \$24.00 ea
 Convert Only
 6 Needed



1224 Conv. Rear Arm Rest
 Assembly. Excellent Metal
 Reproduction \$575.00 pr.



Floor Brace 4th from Front (22")
 9012 Left \$110.00
 9013 Right \$110.00



CONVERTIBLE ONLY
 9017L Outside LH Cowl Support \$65.00
 9017R Outside RH Cowl Support \$65.00

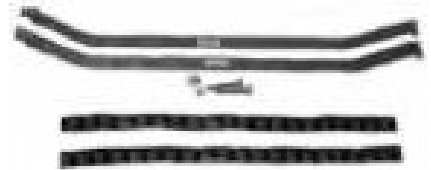

1501 Gas Tank Straps with Bolt & Pad
 \$59.00



1313 Left Outer Headlight Housing
 1314 Right Outer Headlight Housing
 \$110.00 ea

1301 Body Plug Kit \$50.00



1311 Left Inner Headlight Panel
 1312 Right Inner Headlight Panel
 \$ 97.00 ea

“AUTO SKATE”

1250 lb capacity per skate, 4" casters

Set of 4 Auto Skates w/storage cart \$ Call
 Single Auto Skate \$ Call



**Move Your Car Without Jacking or
 Waiting for your Friends to Stop By
 These can help you move several cars into
 a smaller area, safely and easily**

**If you don't see what you need, give us a call.
 800-828-2212**



9002 Left Outer Rocker Panel \$115.00
9003 Right Outer Rocker Panel \$115.00



9081L Left Inner Rocker \$129.00
9081R Right Inner Rocker \$129.00



7757 Lft Rear Lower Qtr Front Patch Panel \$130.00
7758 Rt Rear Lower Qtr Front Patch Panel \$130.00



7768 Left Trunk Floor \$142.00



7755 Left Rear Lower Qtr Patch Panel \$135.00
7756 Right Rear Lower Qtr Patch Panel \$135.00



7770 Left Trunk Filler Panel \$87.00
7771 Right Trunk Filler Panel \$87.00

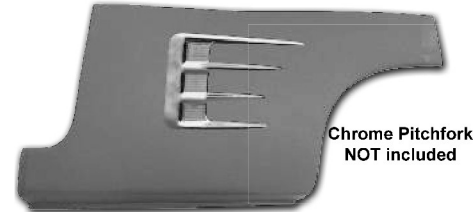

Chrome Pitchfork
NOT included

Impala Lower Qtr. Rust Repair Panel
9085L Left Side 24" x 42" \$189.00
9085R Right Side 24" x 42" \$189.00



7759 Spare Tire Well \$131.00



7769 Rt, Trunk Floor \$142.00

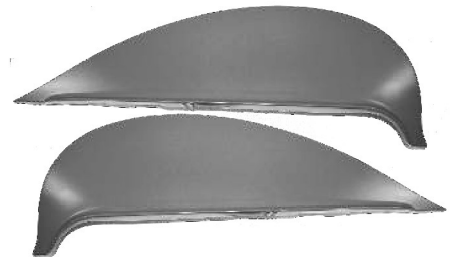

5002 Reproduction Fender Skirts
\$ 199.00 Pr.



9082 Under Deck Lid Body Panel \$299.00
IMPALA ONLY Fits below the deck lid & between the taillights. 30" wide gas door shield housing is attached.



9083 Trunk Gutter - Holds Weatherstrip \$90.00



1500L Left Trunk Floor Brace \$85.00
1500R Right Trunk Floor Brace \$85.00



9082-D Gas Door and Springs \$249.00
(Impala only)



9022 Trunk to Wheelhouse Support Brace \$38.00 ea.

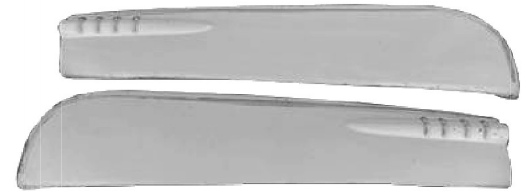

5005 Continental Cruiser Skirts
Fox Craft 6035 Style \$\$\$CALL



9086R Rt Rear Wheel Opening Patch Panel \$79.00
9086L Left Rear Wheel Opening Patch Panel \$79.00



9084 Rear Body to Frame Mount All models except Wagon 54" Long \$ 296.00

ORDERING IS EASY! 800-828-2212

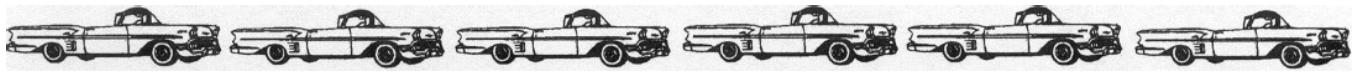

“CONVERTIBLE ONLY”

CONVERTIBLE TOPS

Made from top quality GM pinpoint nylon seems as original.

This top is custom made for our company.

It is cut from an original pattern. There is a difference from your average production top. Don't skimp on your top.

1201	White	- Top of the Line	- 400 Series	\$369.00
1202	Black	- Top of the Line	- 400 Series	\$369.00
		Back Window not included with top.		
4124	PLASTIC BACK WINDOW- Complete with Zipper			\$159.00



1209K

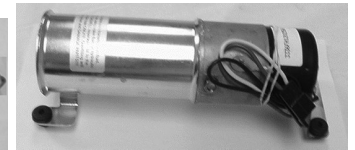

1209 Convertible Top Motor

TOP BOOT COVER

Pre-sewn with vinyl color matched to the interior. Complete with original Naugastay stiffener and snaps.

1203	Black	1204	Green	1207	Gold	\$229.00
1205	Blue	1206	Turquoise	1208	Red	



1216

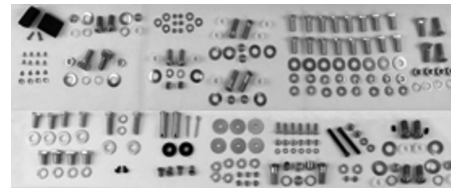

4126 Top Frame Hardware Kit



1222

CONVERTIBLE TOP MISC PARTS

1209K	Top Motor Pump Kit, Pump, Cylinders & Hoses (Items 1209, 1210, 1211)			\$599.00
1209	Top Motor - 12 Volt Pump & Motor Assembly Exact Fit - Comes with installation kit			\$285.00
1210	Top Lift Cylinder - Specifically for 58 Chevrolet. Will match your top cylinder. 1 yr warranty			\$149.00
1211	Hose Assembly - Upper & Lower - Exact Fit			\$ 99.95 pr
4125	Convertible Top Pads			\$ 65.00
4126	Top Frame Hardware Kit			\$139.00
4131	Top Rear Tack Rail - 3 Pieces			\$199.00
	Bottom of the top attaches to this rail and then bolts to rear of car behind back seat. Includes 1 rear & 2 end sections.			
1212	Top Motor Cover - Sheet Metal Part - Looks Orig.			\$ 59.95 pr.
1216	Top Ram Motor Bracket - Mounts to floor of car			\$ 85.00
1222	Hose Retainer Clips - Orig push in clips Helps complete proper restoration. 6 needed			\$ 10.50 ea
1213	Boot Rail Retainer - STEEL			\$140.00
1214	Well Liner			\$ 69.00
1223	Pinch Rail Pads - Assembles between the rear pinch rail and the body			\$ 19.00
1233	Pinch Well Molding Snap Kit			\$ 45.00
1224	Rear Armrest Assembly			\$575.00 pr
1127	Top Weatherstrip - Complete 7 Piece Kit			\$529.00
2153	Top Header Seal			\$ 21.00
2154	Top Header Seal Retainer with screws			\$ 149.00
5011	Convertible Top Header Bow			CALL



4131 3 Pc Top Rear Tack Rail

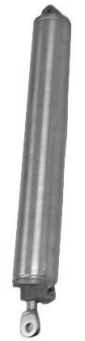

1210



5011

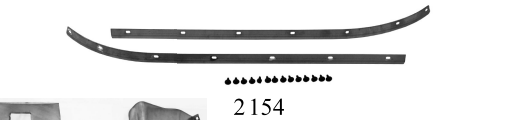

2154



1224



1223



1233



1213

CONVERTIBLE UPPER REAR SEAT PARTS

5505L	Convertible upper rear seat molding LH	\$225.00 ea.
5505R	Convertible upper rear seat molding RH	\$225.00 ea.
5505	Convertible upper rear seat molding - Pair	\$450.00
	These moldings attach to the speaker grill	

CONVERTIBLE DECK LID TORSION RODS

4146	Convertible Deck Lid Torsion Rods Correct Tension	\$199.00 pr
------	--	-------------



4146 Deck Lid Torsion Bars

If you don't see what you need, give us a call.

800-828-2212

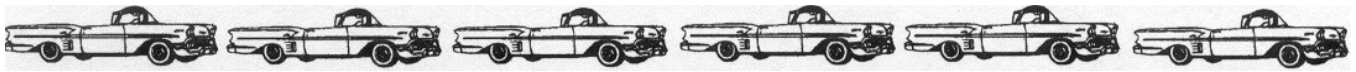

“CONVERTIBLE ONLY”

MISC CONVERTIBLE TOP PARTS

1217	Top Handles - Exact Reproduction Looks Great	\$ 58.00 pr
1235	Top Handle Screws	\$ 2.00 ea
1218	Top Striker Plates	\$ 95.00 pr
1219	Quarter Pivot Screws	\$ 3.50 ea
1221	Top Alignment Pegs	\$ 29.95 pr.
4127L	Top Lock Mechanism Left - NEW	\$129.00
4127R	Top Lock Mechanism Right - NEW	\$129.00
1215	Top Switch Knob Fits & Works Great	\$ 45.00
4113	Top Switch	\$ 99.00
4113S	Top Switch with Knob 2 pc Set	\$135.00



1221



1218 Top Striker Plates



4113S 2 pc Set



4113 Top Switch

SUN VISORS

Pre-sewn on new boards with correct vinyl material, binding, rods & clips.

8100 Red	8122 Black	8125 Dark Blue	
8123 Dark Turquoise	4564 Silver	6059 Gold	
8124 Dark Green	8121 Coral		\$ 159.00 pr.



1217 Top Handles



1215

SUN VISOR BRACKETS

EXACT REPRODUCTION

1234L	Left \$ 33(HT) \$135(Conv)	1234R	Right \$33(HT) \$135(Conv)
-------	----------------------------	-------	----------------------------

SUN VISOR HOOKS

1220		\$ 19.00 pr.
------	--	--------------



4127 Top Lock Mechanism



1219 Pivot Screw

REAR VIEW MIRROR BRACKET

1645C	Excellent Reproduction (Convert Only)	\$ 65.00
-------	---------------------------------------	----------

INTERIOR MOLDING UNION CLIP

Used where moldings meet, directly above rear view mirror.

1229	Made of stainless, exactly like original.	\$ 25.00
------	---	----------



1234 Sun Visor Brkt

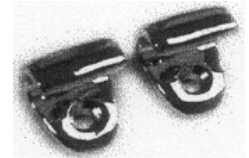

1220 Sun Visor Hooks

REAR SPEAKER SHIELD

Fits on back of rear seat to protect 1 rear speaker.

1230	Can be seen from the trunk.	\$ 20.00
------	-----------------------------	----------



1645C Mirror Brkt



1229

QUARTER WINDOW UPPER CHROME FRAME

1227	EXACT REPRODUCTION	\$ 89.00 ea.
------	--------------------	--------------

QUARTER WINDOW LOWER POT METAL CHANNEL

1228	EXCHANGE ONLY	Call
------	---------------	------

QUARTER WINDOW ASSEMBLY

Includes new upper quarter window frame, re-chromed lower channel, new glass completely assembled. Ready to install.

1624R	RH	EXCHANGE ONLY	\$ 399.00
1624L	LH	Quarter Window Assembly	\$ 399.00



1237



1230 Rear Speaker Shield

CONVERTIBLE QTR WINDOW GUIDE

1237R	Right Side	\$ 129.00 ea
1237L	Left Side	\$ 129.00 ea

Upper Qtr Frame
Reproduction

1227 Qtr Window Up Frame

CONVERTIBLE QUARTER WINDOW PIVOT BRACKET

4143L	Left Side	\$ 119.00
4143R	Right Side	\$ 119.00

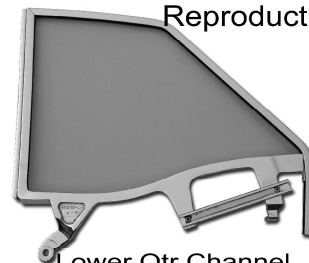

Lower Qtr Channel
Re-Plated Exchange Needed
1624



4143 Qtr Window
Pivot Bracket

ORDERING IS EASY!

800-828-2212



ROOFRAIL & CONVERTIBLE TOP RUBBER

1231	Windshield Pillar Post Seals, Hardtop & Convertible		\$ 7.00 pr.
2043	Roof Rail Weatherstrip - 2dr Ht.		\$ 31.00 pr.
2743	Roof Rail Weatherstrip - 4dr Ht.(2-2dr ht sets + some cutting)		\$ 62.00
2153	Convertible Top Header Seal		\$ 21.00 ea.
1127	Convertible Rubber Kit - 7 Piece Set		\$529.00

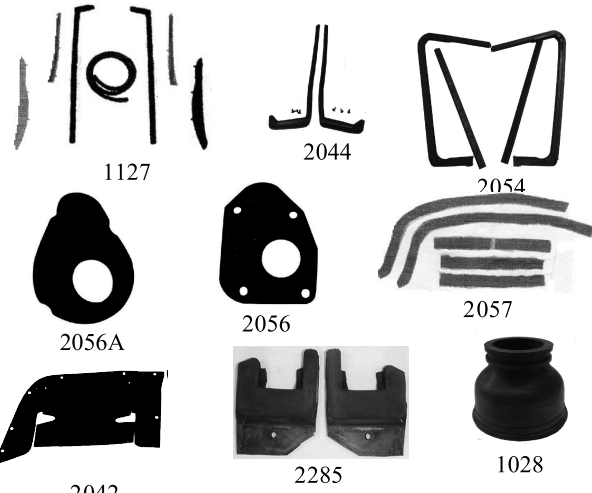

DOOR WEATHERSTRIPPING

2010	Hardtop & Conv. Door Weatherstrip		\$ 79.00 pr.
2044	Door "j" Weatherstrips - All Models		\$ 20.00 pr.
1003	Sedan Door Weatherstrip with Clips		\$ 69.00 pr.
1000	Lower Door Drain Seals	Set	\$ 11.00
1001	Upper Door Drain Seals	Set	\$ 15.00

WINDOW RELATED ITEMS

2038	Impala Convertible Felt Kit (Whiskers)	8 pc.	Set	\$139.00
2039	Impala Hardtop Felt Kit (Whiskers)	10 pc.	Set	\$139.00
2188	Bel Air 2 Dr. Hardtop	8 pc.	Set	\$125.00
2168	Bel Air 4 Dr. Hardtop	8 pc.	Set	\$135.00
2162	Bel Air 2 Dr. Sedan	10 pc.	Set	\$140.00
2163	Bel Air 4 Dr. Sedan	8 pc.	Set	\$128.00
2161	Biscayne 2 Dr. Sedan	8 pc.	Set	\$135.00
2189	Biscayne & Delray 4 Dr. Sedan	8 pc.	Set	\$125.00
2165	Brookwood 4 Dr. Wagon	8 pc.	Set	\$169.00
2040	Front Windshield Gasket - Specify Model			\$ 55-105.00
2041	Back Glass Gasket - Specify Model			\$ 98-105.00
3040	Ht & Conv. Side Glass Installation Rubber			\$ 30.00
2054	Vent Window Seals, Impala, Ht. & Conv.	4 pc.	Set	\$ 95.00
2054B	Vent Window Seals, Bel Air, 2 Dr. & 4 Dr.	4 pc.	Set	\$235.00
2054C	Vent Window Seals, Sedan 2 Dr. & 4 Dr.	4 pc.	Set	\$229.00
2054D	Vent Window Seals, Sedan Delivery	4 pc	Set	\$219.00
2285	Quarter Window U Jambs, Hardtop			\$ 23.00 pr.
2286	Quarter Window U Jambs, Convertible			\$ 23.00 pr.
2300	Quarter Window Seals			\$ 15.00 pr.
1128	Quarter Window Stops			\$ 9.00
1124	In-Door Window Stops - Lower			\$ 4.50 pr.
1125	In-Door Window Stops - Upper			\$ 3.50 pr.
1126	Vent Assembly Window Stops			\$ 15.00 pr.
2210	Hardtop Division Bar Channels			\$ 25.00 pr.
2208	Bel Air, Biscayne, & Delray 2 Dr. Sed Upper Channels			\$ 95.00

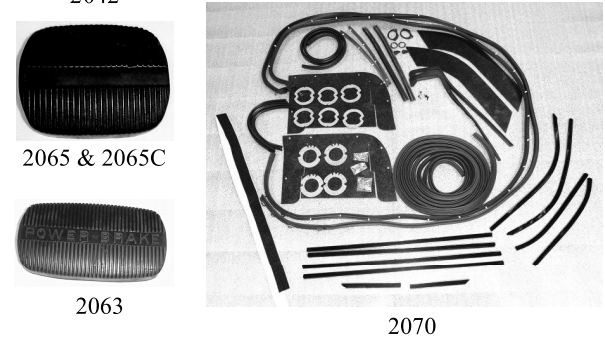

WEATHERSTRIP KIT

2070 Impala Hardtop & Convertible \$325.00
 Includes: Formed Fuzzy Kit, A-arm seals, hood to cowl seal, door weatherstrip, qtr window seals, paint gaskets, trunk weatherstrip, J-strips, pillar post seal, lens gaskets, Please Order Roof Rail Seals Separately.

UNDER THE HOOD ITEMS

2042	A Arm Seals	\$ 22.50
1493	Clips for A Arm Seals 12 Needed	\$ 1.75 ea
1027	Firewall Grommet, Main Wire Harness	\$ 7.00 ea.
1123	Firewall 4 Wire Grommet	\$ 6.00 ea.
2060	Hood to Cowl Seal	\$ 12.00 ea.

RUBBER BUMPERS INTERIOR& PARTS

1069	Glove Box Door Bumpers	\$ 1.50ea
1052	Rear License Plate Bumper	\$ 1.30ea
2074	Gas Door Bumper	\$ 1.65pr
1053	Door Bumpers (2 needed per Door)	\$.90ea
1222W	Hood Adjustment Bumpers	\$ 5.00
2322	Trunk Bumpers (2 needed)	\$.90ea
1120	Hood to Fender Bumper (1 Pr needed)	\$ 4.00pr
2700	Bumper Set - 2 Drs (all of the above)	\$ 13.75
2701	Bumper Set - 4 Drs (All of the above)	\$ 17.35
2185	Gear Shift Grommet - Column	\$ 15.00ea
2067	Emergency Brake Pedal Pad	\$ 5.75
1505	Accelerator Pedal - Rubber	\$ 12.00
1505A	Accelerator Pedal Studs Pair	\$ 5.00
2064	Accelerator Boot	\$ 12.00
2063	Power Brake Pad for Automatic	\$ 8.50
2065	Brake Pad - Standard	\$ 10.00
2065C	Clutch Pad - Standard	\$ 10.00
2066	Brake Pad - Auto w/out Power	\$ 9.00
2056	Steering Column Seal for Automatic	\$ 16.00
2056S	Steering Column Seal for Standard	\$ 16.00
2056A	Steering Column Seal Sponge	\$ 7.00

MISCELLANEOUS SEALS - GASKET & RUBBER PARTS

1090	Rear Body to Bumper Seal	\$ 16.00
2045	Lens Gasket Kit - For All Lights	\$ 28.00
2046	Antenna Base Gasket	\$ 6.00
2057	Fender Anti-Squeak Seals	Set \$ 25.00
2058	Front Splash Pan Seals	Set \$ 17.00
2059	Door Handle & Lock Gaskets	Set \$ 4.00
1103	Inner Fender Seal	Set \$ 17.00
2000	Trunk Weatherstrip - Exact Profile (1 needed)	\$ 22.00
2052	Body Mounts - Except Convertible	Set \$ 69.00
1121	Core Support Park Lamp Grommet	Set \$ 2.50 ea
1948	Taillight to Body Rubber Seal	Set \$ 8.00
1507	Fuel Sending Unit Gasket	\$ 1.50
1122	Speedometer Cable Grommet	\$ 5.00
1030	Butyl Setting Tape 10' roll	\$ 20.00
1031	Continental Kit Bumper Seals	\$ 16.00
1028	58-60 Strong Column Seal, U-Joint	\$ 24.95
1032	Fender Skirt Gasket - Set	\$ 14.50

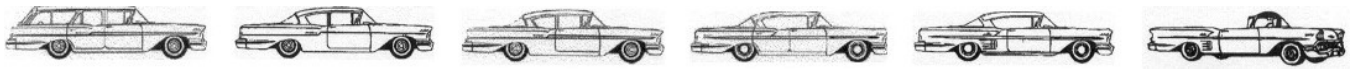

NUTS - BOLTS - CLIPS

1229	Conv. Interior Windshield Mldg. Union Clip	\$ 25.00
1301	Plastic 7 Rubber Body Plug Kit	\$ 50.00
1528	Air Cleaner Wing Nut	\$ 2.00
1529	Air Cleaner Wing Nut - 348 Set of 3	\$ 6.00
1470	Under the Hood Wiring Strap	\$.75 ea.
1471	Inner Fender Wire Retainers	\$ 1.00 ea.
1472	Rear Window Molding Clip 23 needed	\$.50 ea.
1474	Cowl Tag Rivets - 2	\$ 10.00
1475	Door Hinge Pin Kit - 1 door	\$ 12.00
1476	Linkage Rod Clips	\$ 1.00 ea.
1477	Brake Hose Clips	\$ 1.00
1478	Bath Tub Style Clip - <i>Side Molding</i> Door and Qtr	\$ 2.00
1478Q	Upper Bead Molding Clip	\$ 2.00
1479	Union Clip - <i>Joins the upper & lower quarter moldings to rear spear.</i>	\$ 15.00
1480	Bath Tub Clip Tool - to install bath tub clip	\$ 24.95
1481	Rocker Molding Clips Set	\$ 21.00
1483	Pitch Fork Clip - Impala Only Set	\$ 10.00
1484	Impala Rear Window Lower Corner Mldg Clip	\$ 10.00
1486	Door End Mldg Clips w/screws (2 per door)	\$ 4.00 ea.
1487	Body Mount Bolt Kit	\$ 22.00
1488	Interior Garnish Molding Screw Kit	\$ 12.00
1489	Side Molding Clips - Biscayne/Delray	\$ 1.50 ea.
1490	Grille Repair Clip - <i>repairs torn grille ends</i>	\$ 15.00 ea.
1491	Power Steering Hose Retainer	\$ 25.00
1492	Impala Windshield Upper Molding Clip	\$ 3.25 ea.
1492S	Impala Windshield Upper Mldg Clip Set of 6	\$ 20.00
1493	Clip for A-Arm Seals ...12 needed (Set \$20.00)	\$ 1.75 ea.
1494	Front Fender Spear T-Bolt, Impala & BelAir	\$ 2.10 ea.
1673	Impala Steering Wheel Paint Dividers -Set of 4	\$ 18.00
1709	Wiper Arm Trans. Bushing w/rubber seal	\$ 3.25 ea.
1709S	Wiper Arm Trans Bushing Rubber Seal	\$.50 ea.
1710	Wiper Arm Trans. Union Clip	\$ 2.00
1711	Lower Grille Retainer Clip Set	\$ 7.00
1741	Retainer & clips for Hood Ins Pad	\$ 32.00
1742	Hood Pad Center Retainer Clip	\$ 15.00
1966	Bumper Bolt w/nuts	\$ 3.00 ea.
2052	Body Mounts, Except Convertible Set	\$ 69.00
2062	Body Mounts Convertible Set	\$ 48.00
1482	Side Molding Clip Set - Biscayne 2 Dr. Sedan	\$ 99.00
1482d	Side Molding Clip Set - Delray 2 Dr. Sedan	\$ 99.00
1485	Side Molding Clip Set - Impala	\$159.00
1485b	Side Molding Clip Set - Bel Air	\$159.00
1495	Front End Sheet Metal Fastener Kit - 295 pcs	\$ 80.00
	Attaches Fenders, Inner Fenders & Pans to Car	
1468	Exterior Windshield Mldg Union Clip	\$ 22.00
4126	Convertible Top Frame Hardware Kit see pg 21	\$139.00

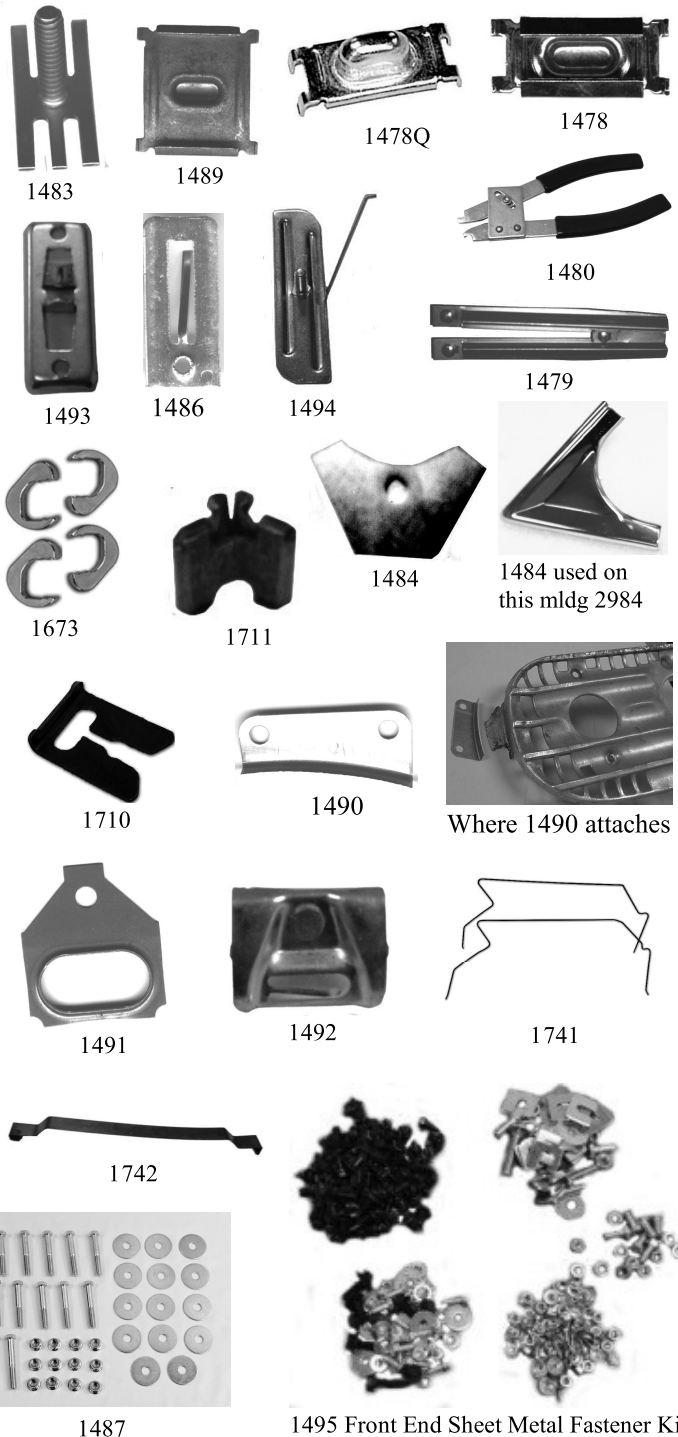

**FOR THE BEST RESTORATION, BUY THE CORRECT CLIPS
OUR CLIPS ARE MADE TO BE USED ON SPECIFIC MOLDINGS**

<p>1485 Impala 34 for Lower Qtr. Side Mldgs. 28 for Door Moldings 22 for Upper Qtr. Bead Mldgs. 20 for Rear "S" Moldings 18 for Front Fender Spear 12 for Quarter Scripts 2 for Quarter Side Union 14 for Pitchfork</p>
--

<p>1485b Bel Air 34 for Lower Qtr Side Mldgs. 28 for Door Moldings 22 for Upper Qtr. Bead Mldgs. 20 for Rear "S" moldings 18 for Front Fender Spear 12 for Quarter Scripts 2 for Quarter Side Union</p>

<p>1482 Biscayne 2 Door Sedan 28 for Fender Moldings 28 for Door Moldings 28 for Lower Qtr. Mldgs. 30 for Upper Qtr. Mldgs. 10 for Scripts 19 for Rear "S" Mldgs.</p>
--

<p>1482d Delray 2 Door Sedan 14 for Fender Moldings 10 for Door Moldings 20 for Lower Qtr. Mldgs. 30 for Upper Qtr. Mldgs. 10 for Scripts 14 for Rear "S" Mldgs.</p>

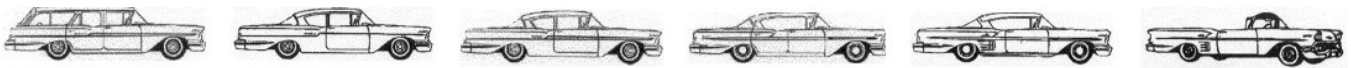

DECALS & INSTRUCTION SHEETS

- 1257 Lacquer Paint Decal - For Cowl \$ 12.00
- 1258 Pitch Fork Decal \$ 10.00
- 1259 Fender Spear Decal, Easier than painting, correct low gloss look, fits in grooves perfectly. Does both moldings \$ 29.00
- 1260 Generator Warning Tag \$ 3.00
- 1261 Oil Filter Decal \$ 2.50
- 1262 Radiator Coolant Warning Tag For all cars using GM coolant \$ 4.00
- 1263 Windshield Washer Decal For lid of all cars with glass bottles. Please specify if you vacuum or manual \$ 2.50
- 1264 Air Condition Aluminum Tag For evaporator box under hood Adhesive back - 2 colors \$ 6.00
- 1265 "Air Conditioned" Window Decal \$ 4.00
- 1266 Tire Inflation Decal \$ 2.50
- 1267 Jacking Instruction Sheet - All Models \$ 5.00
- 1268 Positraction Sticker \$ 4.00
- 1269 Factory Window Sticker for accessories installed by dealer \$ 4.50
- 1270 Suggested Dealer Price Listing \$ 2.50
- 1271 Transmission Operation Instructions \$ 4.00
- 1272 Door Alignment Inspection - Set of 4 \$ 5.00
- 1273 Air Cleaner Decal \$ 4.50
- 1274 Crank Case Breather Decal \$ 2.50
- 1275 Delco-Remy Detailing Tags \$ 12.50

- 1650A Aluminum Dash Restoration Kit. 100% correct. Screen Printed Like Original Looks Great! Helps cover those imperfections. \$ 139.00
- 1834 Wheel Cover Decal Kit - Set of 12 \$ 59.95
- 1277 Positraction Tag - Metal Attaches to rear end housing \$ 12.95
- 1276 Decal Package - Crank Case, Air Cleaner, Door Alignment, Jacking Instructions, Tire Inflation, Windshield Washer & Oil Filter Decals - Specify Carbs \$ 18.00

LITERATURE

- 1280 Shop Manual \$ 27.50
- 1281 Owners Manual \$ 12.00
- 1284 Accessories Installation \$ 20.00
- 1285 Assembly Manual \$ 28.00
- 1286 Convertible Top Folding Instructions \$ 9.00
- 1287 Chevrolet Accessories & Price Listing \$ 5.00
- 1288 Literature Package - Shop Manual, Assembly Manual & Owners Manual \$ 53.00

NOTICE
IMPORTANT
 EXTERIOR FINISH

Each head and fender of this car are painted with a new glass-finish of improved durability. This paint is incompatible with lacquers and synthetic enamels previously in common use.
 Consult an authorized Chevrolet Dealer for special technical information should repairs or service be required. **DO NOT DETACH**



1258



1263

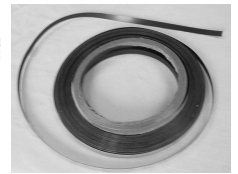

1259



1266

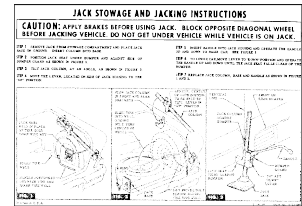

1267

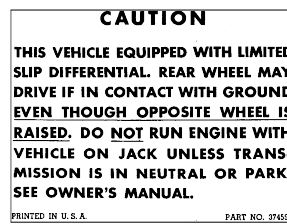

1268

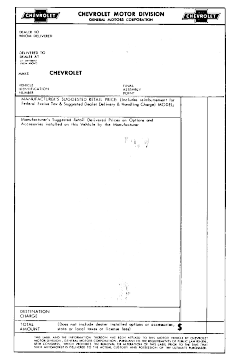

1269

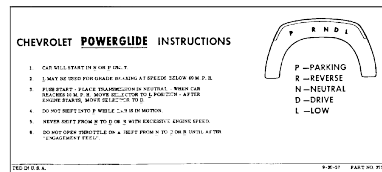

1271



1650A



1276



1274

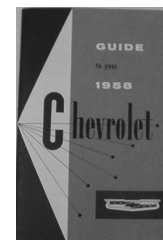

1281



1275

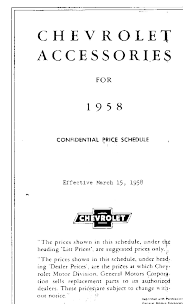

1288



1286

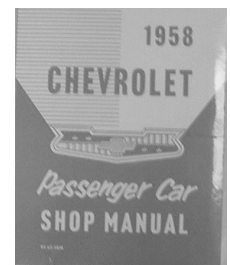

1280

If you don't see what you need, give us a call. 800-828-2212



CONTINENTAL KIT

Show Quality Plating - Correct Tire Size
 Easy Installation - In Stock
 1970 \$3,499.00



INDIVIDUAL CONTINENTAL KIT PARTS

1971	BUMPERS - 7 Needed	\$.50 ea.
1972	CARRIER ASSEMBLY	\$160.00
1973	CARRIER PIN - SPRING RETAINER	\$ 29.95
1974	LEVER ASSEMBLY Complete with rubber lift grip	\$399.00
1976	RING SPRING Zinc coated to prevent rust	\$ 24.95
1977	BAR SPACERS Show quality plating - 2 Required	\$ 29.95 ea.
1981	LICENSE PLATE LIGHT	\$ 39.00
1983	RUBBER SEAL	\$ 19.00
1988	BACK PAD - Piece latch bolts to	\$ 60.00
1989	BACK PAD LATCH GASKET	\$ 10.00
1990	FACEPLATE - Pre-drilled holes	\$150.00
1991	TIRE RING - Un-chromed	\$250.00
1992	TIRE RING - Chromed	\$499.00
1993	INNER TRUNK BRACE - 2 Needed	\$ 25.00
1913	TRIM - "CHEVROLET" SCRIPT	\$ 39.00
1914	TRIM - "V" POT METAL REPRO.	\$ 39.00



1974



1973

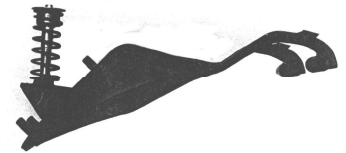

1972



1976



1988



1991

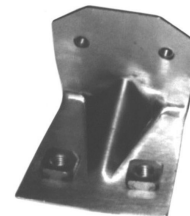

1993

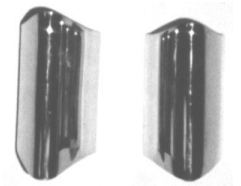

1977

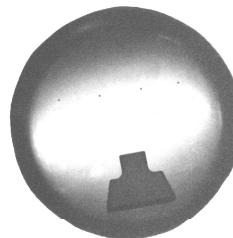

1990



1913



1914

ORDERING IS EASY!
800-828-2212

TILT STEERING COLUMNS

\$199.00

32" or 30" Tilt Columns
Column Shift
or
Floor Shift

CHROME OR BLACK

We Also Offer a Paintable Column
You Can Paint To Match Your Car



COLUMN & STEERING WHEEL PACKAGES
PICK YOUR TILT COLUMN
PICK YOUR STEERING WHEEL
EXACTLY THE WAY YOU WANT IT

CUSTOM STEERING WHEELS

\$175.00

14" 15" Wheels
Full Wrap
Leather
Woody
Half Wrap



See page 17 for details.

Move Your Car Without Jacking
or Waiting for Your Friends to Stop By

These Can Help You Move Several Cars
Into a Smaller Area, Safely and Easily

"AUTO SKATE"

1250 lb capacity per skate; 4" caster

Set of 4 auto skates w/storage cart \$Call
Single auto skate \$Call



ORDERING IS EASY!

800-828-2212

We Buy

58-59 Chevy NOS New Old Stock

CHEVROLET ACCESSORIES

GENERAL MOTORS PARTS DIVISION • GENERAL MOTORS CORPORATION

Call Gordon

800-828-2212



**LARGE SELECTION OF USED PARTS
MECHANICAL • BODY
INTERIOR & MORE**

**CALL FOR AVAILABILITY
& CURRENT PRICE**

***AUTO CITY CLASSIC* 800/828-2212**

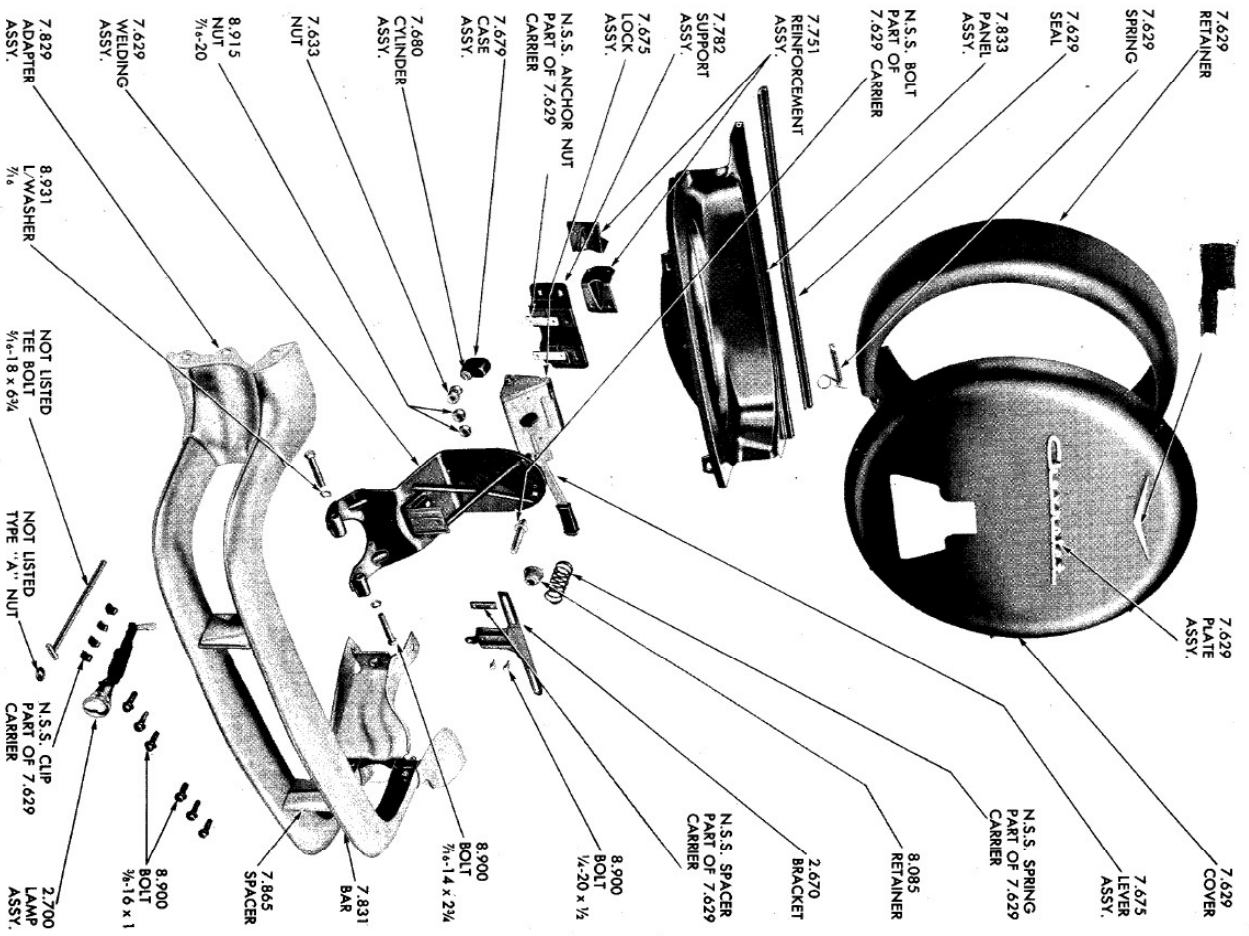

1958 CONTINENTAL WHEEL CARRIER—EXPLODED

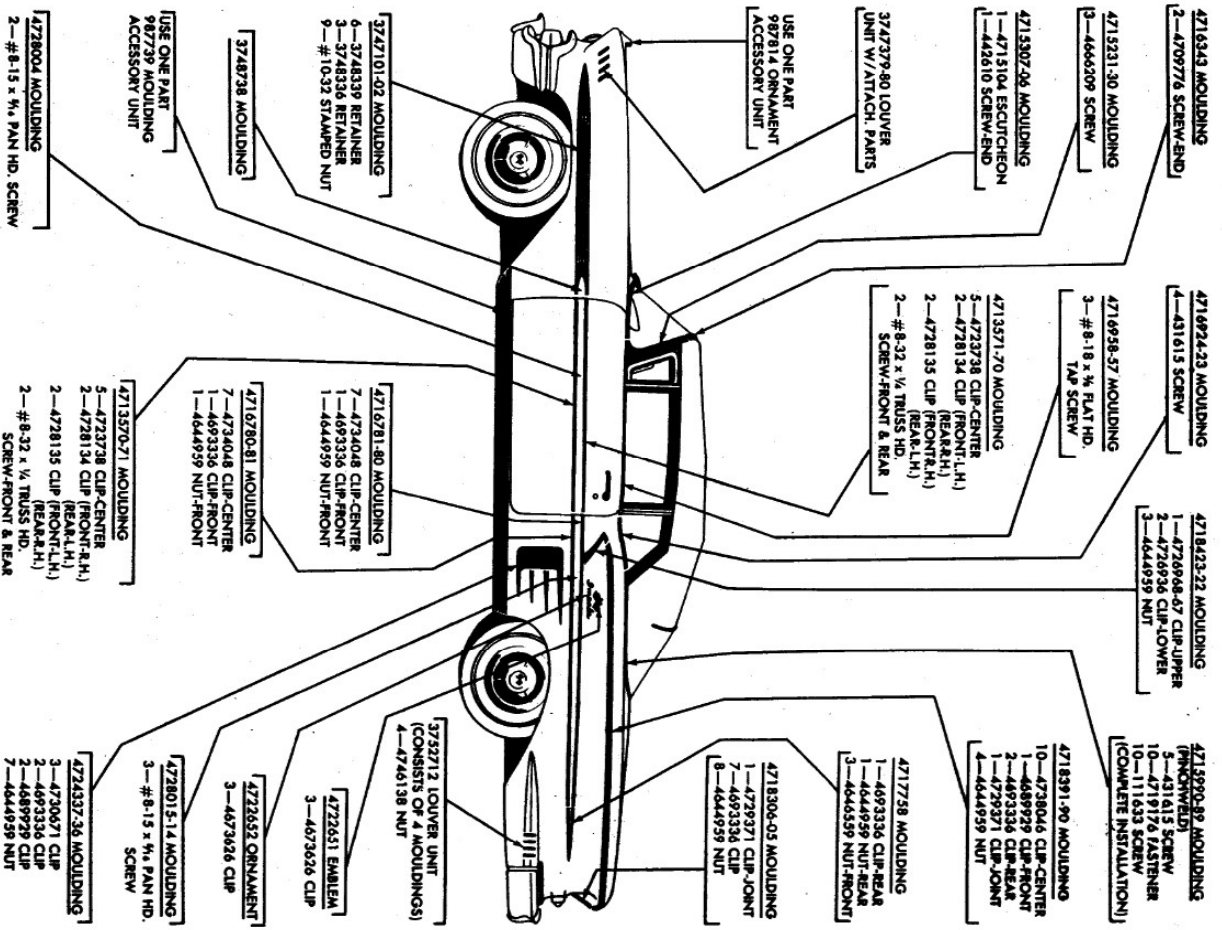

1958 IMPALA CONVERTIBLE (MODEL 197-197)

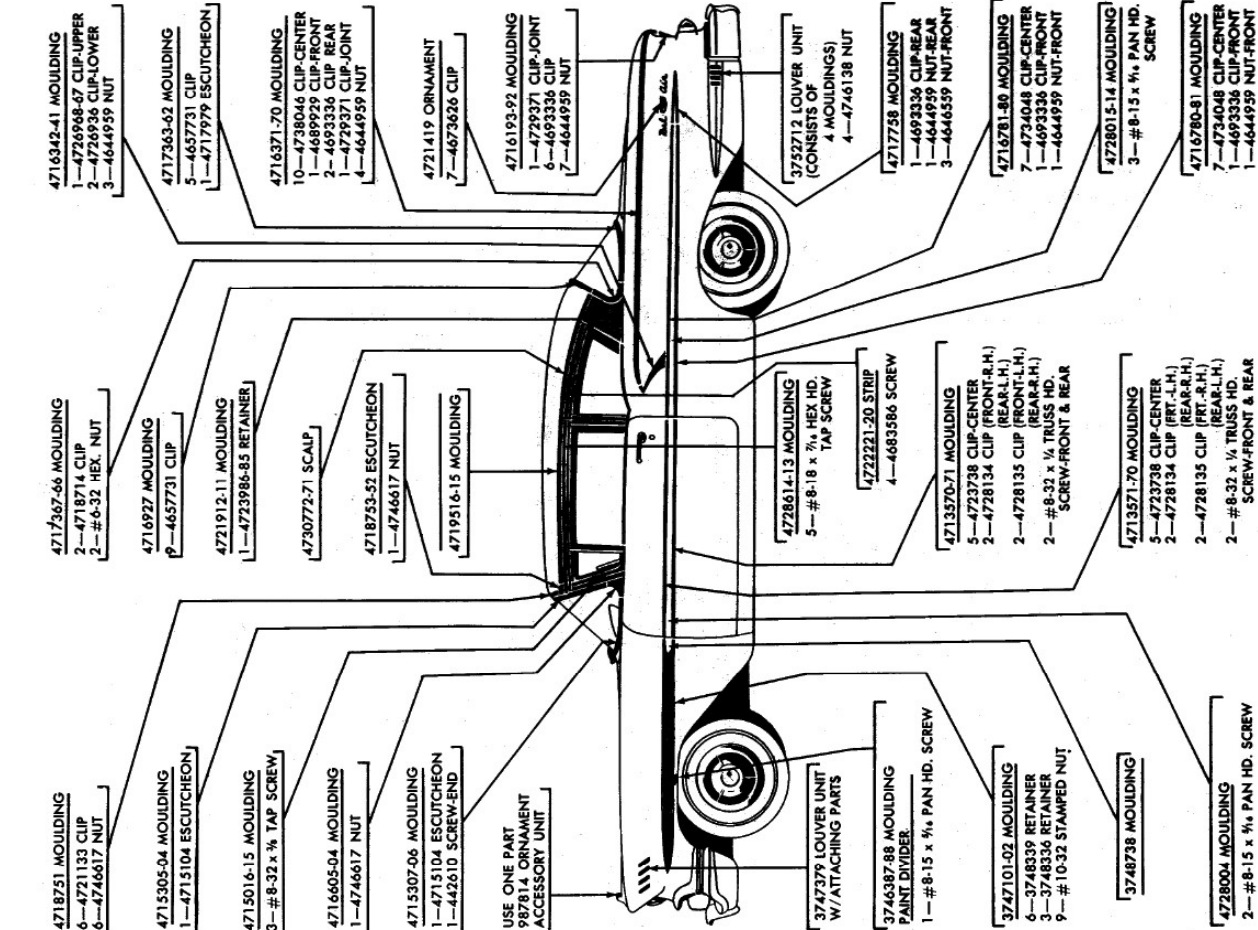

1968 BEL AIR SPT. GPE. (MODEL 1791-1861)

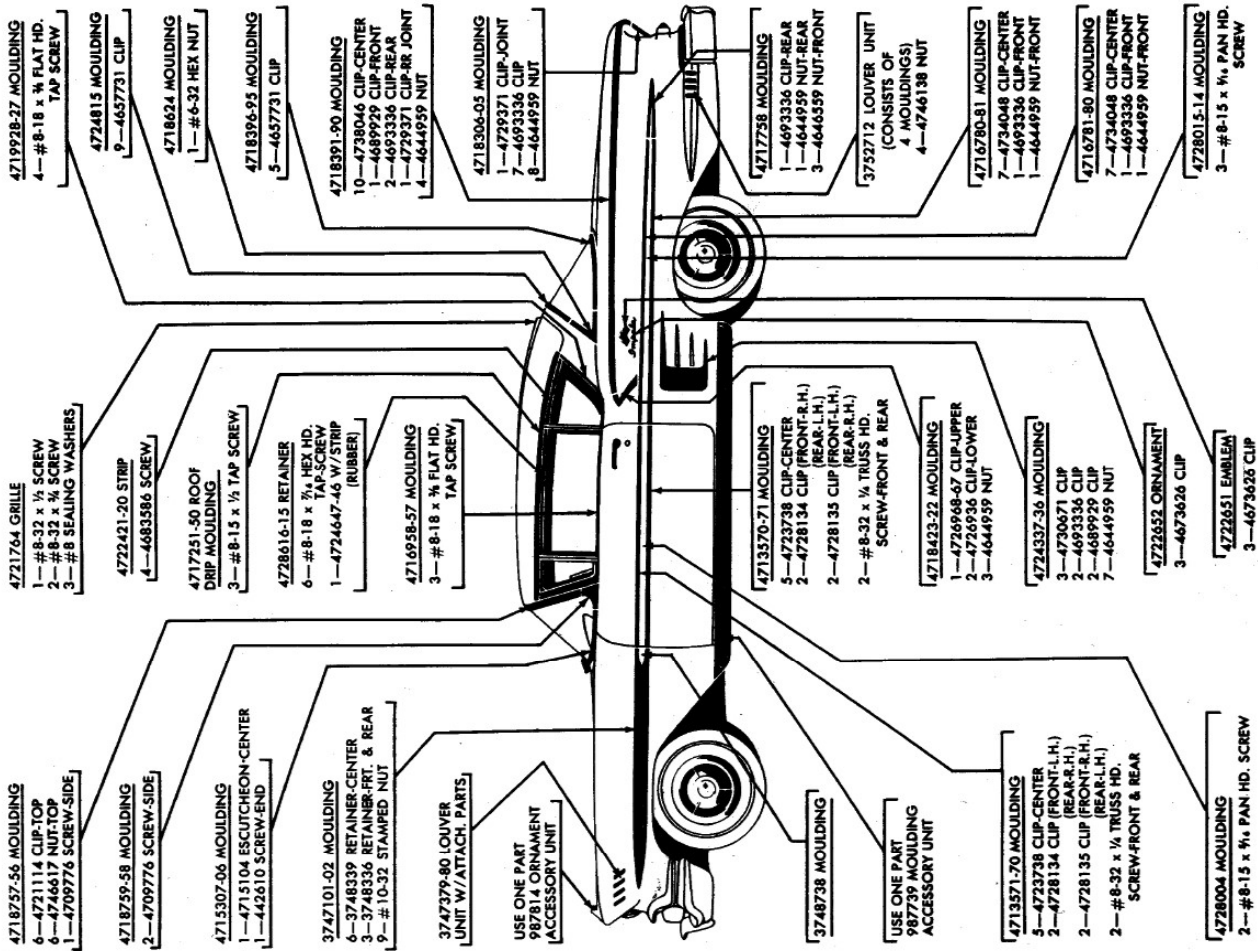

1968 IMPALA SPT. GPE. (MODEL 1747-1847)

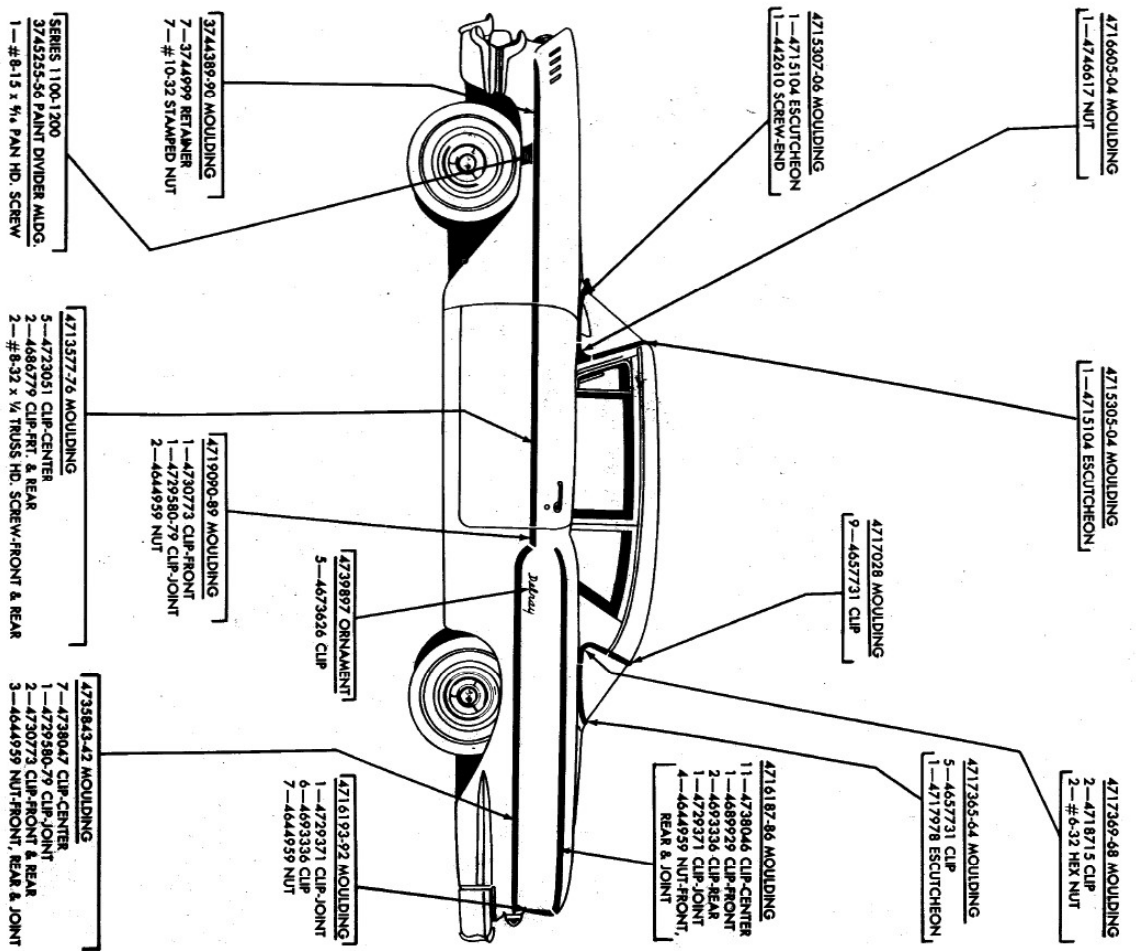

1958 DELRAY 2 DR. SEDAN (MODEL 1141-1241)
1958 UTILITY SEDAN (MODEL 1121-1221)

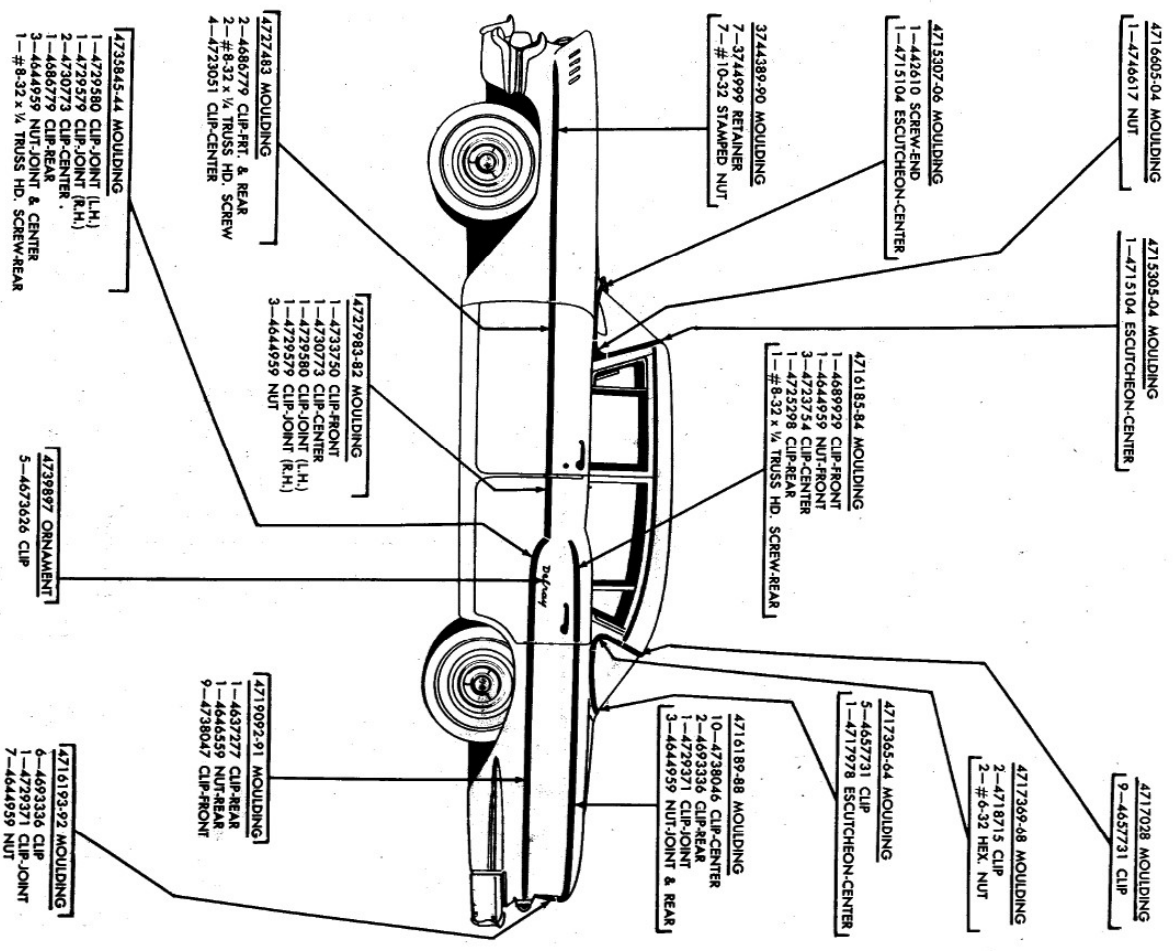

1958 DELRAY 4 DR. SEDAN (MODEL 1149-1249)

More Items Available for Classic Cars & Trucks From 1930's to 1970's - All Makes and Models



Glass



Complete Glass Packages

(all parts also sold separately or custom packages)

- Buick
- Cadillac
- Checker
- Chevrolet
- Chrysler
- Corvair
- DeSoto
- Dodge
- Falcon
- Ford
- GMC
- Lincoln
- Mercury
- Oldsmobile
- Packard
- Pontiac
- Plymouth
- Studebaker

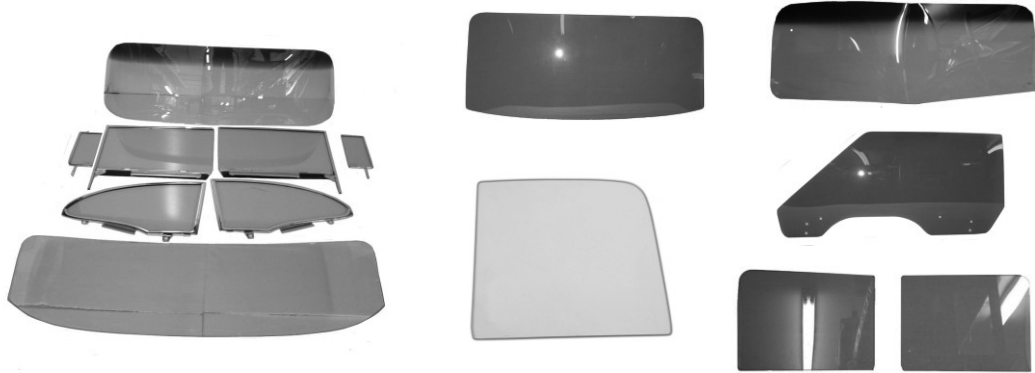

Custom Cut Glass Available
Give Us a Call!

Frames, Channels & Seals

(pre-assembled side glass also available)



Power Window & Power Vent Kits

Kits and Parts Available for Buick, Camaro, Pontiac & More



**Street Rods - Hot Rods - Muscle Cars - Classics
We're The Largest Manufacturer of Classic Auto Parts**

Gas Tanks

GM - Ford - Chrysler
400 Models Available



Polished Stainless
Steel Gas Tanks
Available

Radiators

Fullsize Chevy
Camaro
Chevelle
GTO, Cutlass
Skylark Nova & More



Brakes

Disc Brake Kits & Parts For:
Buick, Cadillac, Chevy, Ford
GM A-Body, Mercury, Mopar
Oldsmobile and Pontiac



INDEX

A-Frames	18	Door Striker Plates	6	Idler Arm	18
Air Cleaner & Parts	15	Door Pads	7	Ignition Lock	5
Air Conditioning & Parts	16	Door Pad Interior		Ignition Switch	5
Alternator Conversion Brkt	17	Aluminum	6, 7	Ignition Wires	14
Antenna	4	Door Hinge Pin	24	Instructions	25
Armrests	6, 8, 19, 21	Drop Spindles	12	Instrument Lenses	4
Ashtrays	5	Electrical	10	Interiors	7
Auto Skates	19	Emblems	2, 5	Kick Panel Trim	6, 7
Ball Joints	18	Emergency Brakes	12	Lenses	3, 4, 6
Ballast Resistor	14	Engine Kits & Parts	14	License Plate Parts	1
Battery, Cables & Tray	10	Exhaust Ports	2	Lifters	14
Body Mount Bolt Kit	24	Exhaust Parts	15	Lock Sets	6
Body Mounts	24	Exterior Side Moldings	1	Manuals	25
Body Panels	19-20	Exterior Trim	2	Master Cylinders	11
Body Plug Kit	19	Fender Skirts	20	Mirrors Exteriors	2
Brake Booster	11	Fender Spear	1	Mirrors Interiors	5
Brake Lines	12	Fender Extensions	1	Moldings	1, 2
Brake Kits	11	Firewall Pad	5	Molding Clip Sets	24
Brake Items	12	Floor Pans & Braces	19, 20	Motor Mounts	18
Bumpers Chrome, Brkts	1	Floor Mats	8	Mufflers	15
Cam Bearings	14	Fuel Gauge	5, 13	Neutral Safety Switch	5
Camshaft	14	Fuel Lines	13	Nuts, Bolts	24
Carburetor	13	Fuel Pump	13	Oil Pressure Switch	14
Carpet	8	Fuzzy Kits	23	Oil Pump	14
Cigarette Lighter	5	Gas Pedal	13	Odometer Cluster	4
Clips	24	Gas Tank	13	Package Trays	7
Clock	5	Gas Station Pump	28	Park Lights	1, 3
Clutch Pad	23	Gaskets & Seals	23	Patch Panel	20
Coat Hooks	5	Gear Shift Lever	5	Pistons	14
Column Seal	23	Generator Brackets	17	Points	14
Columns, Tilt	17	Glass Channels & Frame	9	Power Steering	17
Condenser	14	Glass	9	Power Vent Windows	9
Continental Kit & Parts	26	Glove Box Items	5	Power Windows	9
Convertible Only Parts	21-22	Grille	1	Proportioning Valve	12
Convert Top Header Bow	21	Grommets	23	Push Rod	14
Cooling	16	Headliners	7	Quarter Bead Molding	1
Cowl Supports	19	Heating	16	Radiator	16
Cowl Tag Rivets	24	Heater Control Valve	16	Radio, Orig, AM/FM, CD	4
Dash Items	5	Hood Pad, Clips, Spring	3	Ram Bushing Kit	17
Dash Repair Kit	5	Hood "V"	1	Road Draft Tube	14
Decals	25	Hood Bars	1	Rocker Panels	20
Dipstick	14	Horn	5	Rocker Moldings	2
Distributor Cap	14	Horn Relay	5	Rod Bearings	14
Dome Lenses & Lights	6	Hoses		Roof Scallop	2
Door Aluminum Exterior		Brake	12	S Moldings	1
Inserts	1	Convert. Top	21	Seals & Gaskets	23
Door Handles Interior	6	Heater	16	Seat Belts	8
Door Handles Exterior	2	Power Steering	17	Seat Covers	8
Door Lock	2, 6	Radiator	16	Seat, Power	6

INDEX

Seat Risers	19
Sending Unit	13
Sheet Metal	19, 20
Shift Indicator	5
Shocks	18
Side Panels, Interior	7
Still Plates	6
Speakers	4
Speaker Screen Rear	4
Spinners	18
Stabilizer Link	18
Steering Columns	27
Steering Wheels, & Pts	17
Street Rod Options	27
Sun Visors	7
Sun Visor Brackets	7
Suspension Kits,	18
Sway Bar Kit	18
Switches	5, 6, 9
Taillight Cups	3
Taillights, Bezels, Lenses	3
Tailpipe	15
Temperature Gauge	5, 16
Tie Rod Ends	18
Tires	18
Transmissions & Parts	14
Trunk Cardboard & Mats	3
Trunk Floor & Braces	20
Trunk "V"	1, 2
Tune Up Parts	14
Turn Signal	5
U-Joint	18
Union Clip	24
Vacuum Advance	14
Valves	14
Voltage Regulator	14
Water Pumps	16
Weatherstrip	23
Wheel Cylinders	11
Wheel Covers	18
Wheel Bearings	18
Wheelhouse Support	20
Window Regulators	9
Window Handles	6
Windshields	9
Wipers & Parts	3
Wire Protectors	6, 20
Wiring Harness	10

◆◆◆◆ ORDERING INFORMATION

Telephone orders are gladly accepted and the most common way to order. We will accept credit card orders by phone. 1-763-444 5880 or 800-828-2212

You can also find many items on our website autocityclassic.com , under 1958 Chevrolet

FAX orders are also accepted. You may access our FAX line 24 hours a day. Please follow the instructions for ordering by mail. Also include your form of payment and your signature and fax to us at 763-444-5985.

To order by mail, write down the exact model and body style of your 58 Chev plus any other information that would relate to the parts you are ordering. List the part number, a brief description and price of the items you wish to order. Make sure you include your shipping address and a phone number. Please call to get current pricing and shipping cost for the items you are ordering. Also include your form of payment. Credit cards and personal checks are accepted, however, orders will be held for bank clearance of your check. A \$20.00 fee will be charged for any returned checks.

◆◆◆◆ METHOD OF PAYMENT

We accept Visa, Master Card, Discover and American Express. All credit card orders must have the account number, expiration date and the cardholder's name and billing address as it appears on your statement. Checks are accepted but orders will be held for bank clearance of your check.

◆◆◆◆ SHIPPING

All orders must have a physical address. We cannot deliver to PO boxes.

All foreign orders must have the entire order prepaid using a money order, or a cashiers check in U.S. funds. Write or call for shipping estimates. There is a \$20.00 handling charge on all foreign orders. All sales are considered final. Be sure when ordering that your order is clear and legible.

◆◆◆◆ RETURNS

All parts returned must be unused and in the original carton. Any return must be made within 30 days. All returns must be authorized in advance. Please call us first.

◆◆◆◆ DAMAGE

It is the responsibility of the carrier for delivery of merchandise in good condition. Please inspect all deliveries within 24hrs and in the presence of the carrier if possible. If you receive an opened or damaged package, have the driver write "damage" on the delivery sheet. Contact your local FedEx or truckline so they can send a representative to inspect the damaged package immediately. That representative will then contact us and we will take the proper steps. In all cases of damage, the parcel must be inspected at the point of delivery to the customer. If this procedure is not followed the carrier cannot be held liable for the claim on the damaged merchandise.

◆◆◆◆ SHORTAGE CLAIMS

In order for us to act quickly on any shortage claim, notify us within 3 days upon receipt of shipment. Any time after this period we cannot be held responsible.

◆◆◆◆ BACK ORDERS

Occasionally we may be temporarily out of stock on some items. Unless otherwise requested, we will back order any item not in stock. If you request no back orders, we will cancel items that are not in stock and issue a refund if due.

◆◆◆◆ REFUSED SHIPMENTS

Customers shall be charged all shipping (both outbound and inbound) and storage charges plus 15% handling fee for all refused shipments.

DUE TO PERIODIC INCREASES FROM OUR SUPPLIERS, PRICES MAY CHANGE WITHOUT NOTICE. WE DO STRIVE TO HOLD THESE CHANGES TO A MINIMUM



These are some of the over 100-58 Chev parts cars in our inventory.
We have every model from convertibles to wagons.



AUTO CITY CLASSIC
763-444-5880